



PORSCHE



The Cayman



Contents

■ The Cayman concept	6	■ Personalisation	104
■ Model range	24	■ Factory collection	128
■ Drive	30	■ Service	130
■ Chassis	54	■ Summary	132
■ Safety	64	■ Technical data	134
■ Comfort	76	■ Index	136
■ Environment	98		



The Cayman concept

Distinctive. Unyielding. Resolute. Strong-willed.
The perfect match.

Do you go your own way?
Do you stop to question the rules,
and prefer to make your own?
Would you rather trust your own
mind than go with the flow?

Then this is the place for you.
Right here in the driver's seat.

The Cayman and the Cayman S.
An uncompromising declaration of
individuality.

**The primary target group:
your central nervous system.**

The Cayman models.



Two different characters. One personality. Their drive for power is impressive, their spirited nature fascinating. Two sports coupés that go beyond all conventions. Two cars that draw their drivers under their spell, forever.

The concept behind the Cayman models is the 'Le Mans Coupé', a sports coupé designed in 1953 specifically for this legendary race and based on the 550 Spyder. Its mid-engine layout is what made this car special. The car's low centre of gravity gave it tremendous agility and cornering dynamics. From this one basic idea came great success, and with this success our experience grew. The result? Two sophisticated sportscars. The Cayman and the Cayman S.

Their uncompromising performance is generated by two engine developments, which stand out above all for their lightweight

construction, power output and efficiency. The Cayman has a 2.9-litre flat-six engine with a power output of 195 kW (265 hp).

Even more impressive are the performance values of the Cayman S with direct fuel injection (DFI, p. 34). The fuel/air mixture is prepared entirely in the combustion chamber after having been metered and injected directly, with millisecond precision. This means even more power and torque. To express this in figures, its 3.4-litre flat-six engine unleashes a mighty 235 kW (320 hp). Depending on the model, it has been possible to reduce fuel consumption by up to 15% and CO₂ emissions by up to 16%.

In either model, this tremendous power is delivered to the road by a precision six-speed manual gearbox.

Porsche Doppelkupplung (PDK, p. 48) is available as an option.

The key elements of PDK are its seven gears, two half gearboxes and two clutches. It features both manual and automatic modes. Gears are changed using the gear selector for PDK, the switches on the three-spoke sports steering wheel or the new optional three-spoke sports steering wheel with gearshift paddles with race track control logic. The gear change takes place in a matter of milliseconds without any interruption in the flow of power. The advantage over a fully manual transmission is the considerably faster rate of acceleration for the same rate of fuel consumption. The advantage over a fully automatic transmission is the perceptible increase in driving dynamics – with a similar level of comfort, and a distinct reduction in fuel consumption.



Cayman S in Carrara White

The handling of the Cayman models is impressive. The tuning of the chassis is undoubtedly sporty, with no compromise on the comfort required for longer journeys.

For a driving experience that is even more involving, consider the optionally available Sport Chrono Package (p. 62). It offers even sportier tuning of the engine and

chassis at the push of a button. The optional mechanically locking rear differential (p. 60) delivers high traction and increased performance. A wider track and generously dimensioned wheels are also your guarantee of a resolutely dynamic driving experience.

The headlight design and LED taillights are a striking feature. Bi-Xenon headlights including

LED daytime running lights and dynamic cornering lights are available as an option.

Fitted as standard, Porsche Stability Management (PSM, p. 72) makes you feel even safer. The system combines a range of safety functions, such as precharging of the brake system, and brake assist.



Cayman in Basalt Black Metallic

A high level of passive safety is provided by the driver's and passenger's airbags, which are fitted as standard, and the Porsche Side Impact Protection System (POSIP, p. 74) with head and thorax airbags.

A look inside the passenger compartment leaves you in no doubt that the car was designed for uncompromising sportiness.

All the important functions are intuitive to control, including the optional Porsche Communication Management (PCM, p. 92) with navigation module, 6.5-inch touchscreen and CD/DVD drive. Optional seat ventilation keeps you cool when the weather is very warm, while the heated steering wheel is a welcome feature on particularly cold days. The optionally available BOSE®

Surround Sound System offers a genuine alternative to the distinctive sound of the engine. In conjunction with PCM, it supports audio playback of audio and video DVDs in the 5.1 digital surround format.

In fact, there remains only one thing to consider: which one suits you best?







Front design (Cayman S)



Rear design (Cayman)

**They say that clothes make the person.
But only style makes you unmistakable.**

Design.

The design of the Cayman models is befitting of their distinctive, sporty character. Their perform-

ance potential is obvious at first sight, for these are true specimens of force and athleticism.

Individual styling features help to define both vehicles so impressively. A constant

interaction of convex and concave curves. A certain style, like no other. Immediately, the front

displays the kind of character that you expect to find in the Cayman models. The front end features

large air intakes, the geometry of which is unmistakable.



Front design (Cayman)

The contouring of the front apron gives the car an extremely purposeful appearance. The front spoiler lip reduces lift at the front axle.

The front wings with their integrated headlights give the

Cayman models a distinctively sporty look.

The headlights feature an imposing design. Both models are equipped as standard with halogen headlights, LED position lights, and fog lights integrated into the outer air intakes.

Bi-Xenon headlights with dynamic cornering lights, including LED daytime running lights, are available on request.

Follow the car's clean lines along the side towards the rear and the impressive design continues. The styling is emphasised by the



Rear design (Cayman S)

distinctly pronounced curves of the front and rear wings and the shape of the doors.

Typically for a coupé, there is a gradual, flowing transition from the A-pillar to the rear. The sharper contour of the side skirts directs the air stream

down to the side air intakes which are designed to facilitate considerable through-flow.

The rear section of the side windows curves dynamically upwards. Extending beyond the side windows are two additional lines that direct attention towards the rear end. One of these lines

continues to frame the large rear screen.



Rear wing (Cayman S)

The second line continues its rearward path to the LED taillight module. The elegant, extendable rear wing reduces lift at the rear axle.

Below, you cannot miss the visible hallmark of the characteristic Porsche sound: the stainless steel tailpipe – twin tailpipes on the Cayman S – integrated into the rear end.

The unmistakable styling of the Cayman models is complemented by the wheel design. The Cayman is fitted with 17-inch wheels as standard, the Cayman S with



Rear wing (Cayman), extended

18-inch wheels. A 19-inch option is available for both models. The result of all these measures? An impressive appearance and refined aerodynamics with a

drag coefficient of only 0.29. This is the principle of Porsche Intelligent Performance.

The Cayman models. Powerful and dynamic, and when it comes to style, they trust in only one direction: their own.



Model range

The forecast for the following pages:
an imminent storm.

It's not just about the drive for individuality or supreme performance. Above all, it's the indescribable intensity with which the Cayman models express these two virtues.

Uncompromising. Unyielding. Completely unimpressable, but extremely impressive.



**You should never doubt your own principles.
The Cayman.**

The Cayman is the driving force behind precisely one attitude: the absolute conviction to remain true to oneself. No middle roads. No compromises. No nonsense.

One of the features that exemplifies this attitude is the mid-engine layout, which ensures a low centre

of gravity and thus a high degree of agility and an extremely sporty drive. The six-cylinder horizontally opposed power unit has a capacity of 2.9 litres. The engine delivers a power output of 195 kW (265 hp) at an engine speed of 7,200 rpm. A maximum torque of 300 Nm is achieved between 4,400 and

6,000 rpm. From a standing start, the Cayman accelerates to 62 mph (100 km/h) in 5.8 seconds. With the optional Porsche Doppelkupplung (PDK), this sprint takes just 5.7 seconds. Top speed is 165 mph (265 km/h) in conjunction with the manual gearbox. Equally impressive,



however, is the 10% reduction in fuel consumption and the 12% reduction in CO₂ emissions, depending on the type of gearbox. The power of the engine is delivered to the road by a precision six-speed manual gearbox. Fitted as standard are 17-inch wheels with a star-shaped design, which

allows an eye-catching view of the powerful brake system. And the interior? The overall impression is simply one of high quality. For instance, the rims of all available steering wheels are covered in smooth-finish leather. The centre console, finished in traditional black, is equipped as standard

with the CDR-30 audio system with 5-inch display. An integrated six-disc CD autochanger is available as an option.

The Cayman has found its way. Its own? Without doubt.



**It takes no prisoners,
except for your free will.**

The Cayman S.

To accept no compromises, to make conscious decisions, to be governed by nothing other than one's own free will, and to have a clear point of view. A highly promising way to build a sports car. For us, it's the only way.

This philosophy was also the basis for the development of the mid-mounted engine with a 3.4-litre capacity and direct fuel injection (DFI, p. 34). The engine delivers a power output of 235 kW (320 hp) at 7,200 rpm, and a maximum torque of 370 Nm

is achieved at 4,750 rpm. This means, it has been possible to reduce fuel consumption by up to 15% and CO₂ emissions by up to 16%, depending on the type of gearbox.



The Cayman S reaches 62 mph (100 km/h) in just 5.2 seconds. Top speed isn't reached until 172 mph (277 km/h). Porsche Doppelkupplung (PDK, p. 48) is available as an option.

The fastest rate of acceleration of 4.9 seconds is achieved in conjunction with the optional Sport Chrono Package.

In addition to having a higher power output, the Cayman S also differs from the Cayman in

its appearance. It has a front spoiler painted in the vehicle's exterior colour, and twin tailpipes in stainless steel. The sound? Distinctive. In keeping with the rest of the Cayman S.

But so much power also needs to be tamed. This is the task of the enlarged brake system with four-piston aluminium monobloc fixed calipers in a striking red painted finish.

To deliver the increased power output to the road, the Cayman S is fitted with 18-inch Cayman S II wheels. Their design exudes pure dynamism – as befits the model's overall look.

In summary, the Cayman S is more than just a sports car. It's a Porsche.



Drive

If you want to take your goals by storm, you had better have the necessary equipment.

Two engines, several goals: high power, excellent driving dynamics and comparatively low fuel consumption and CO₂ emissions. The engine is positioned in the middle of the car, 30 centimetres behind the driver. Just

a few centimetres above road level. Any contact with the accelerator pedal unleashes power that knows only one direction: forwards. And a sound that is second to none.

Two examples of the uncompromising efforts of our engineers. Going forward.

The engines of the Cayman models.

The flat-six engines.

The mid-mounted engines of both Cayman models are compact and lightweight, and the layout is familiar: six horizontally opposed cylinders.

The 2.9-litre engine of the Cayman delivers 195 kW (265 hp) at an engine speed of 7,200 rpm. The maximum torque of 300 Nm is achieved between 4,400 and 6,000 rpm. The engine of the Cayman S features direct fuel injection (DFI, p. 34) and has a

larger capacity of 3.4 litres. Power output is 235 kW (320 hp) at 7,200 rpm. Maximum torque: 370 Nm at 4,750 rpm.

Each of the engines convinces with its outstanding performance figures, extremely smooth

running, optimised gas cycles and tremendous cornering agility. Fuel consumption and CO₂ emissions have been reduced by up to 15% and 16%, depending on the model. All of this is achieved by DFI (in the Cayman S), a lightweight construction and

a host of other engineering advancements, e.g. VarioCam Plus (p. 43). This system increases torque in the lower engine speed range and power output in the upper engine speed range. Injection and ignition are controlled by the engine electronics. The

driver regulates engine power – and of course sound – using the extremely sensitive electronic accelerator pedal.



3.4-litre flat-six engine of the Cayman S

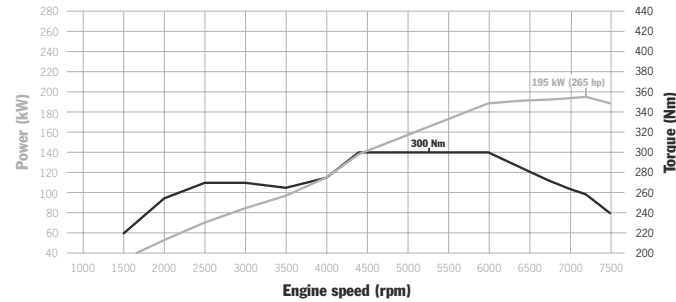

Cayman: 300 Nm between 4,400 and 6,000 rpm, 195 kW (265 hp) at 7,200 rpm

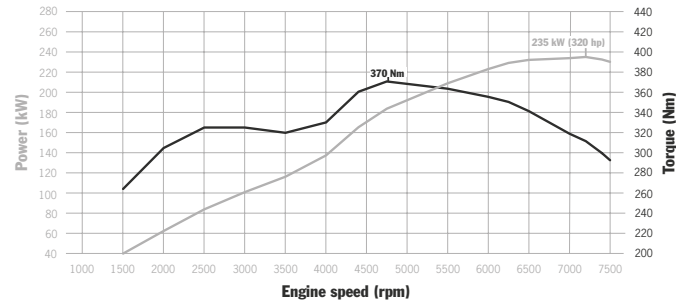

Cayman S: 370 Nm at 4,750 rpm, 235 kW (320 hp) at 7,200 rpm



Cayman S

Direct fuel injection (DFI).

The engine of the Cayman S has direct fuel injection (DFI). With millisecond precision, fuel is injected at up to 120 bar directly into the combustion chamber by

means of electromagnetically actuated injection valves.

The spray and cone angles have been optimised for torque, power output, fuel consumption and emissions by enabling a

homogeneous distribution of the air/fuel mixture and, therefore, effective combustion. Multiple fuel injections take place, depending on the driving style. DFI improves the internal cooling of the combustion chamber by having the mixture

prepared directly in the cylinder. This allows for a higher compression ratio (12.5:1) which helps to deliver more output along with enhanced engine efficiency.

Depending on the type of gear-box, it has been possible to reduce

fuel consumption by up to 15% and CO₂ emissions by up to 16%. Injection is regulated by the electronic engine management system. The exhaust gas cleaning system ensures that emissions remain well below even the strict limits of the Euro 5 emission

standard, thus helping to protect the environment.

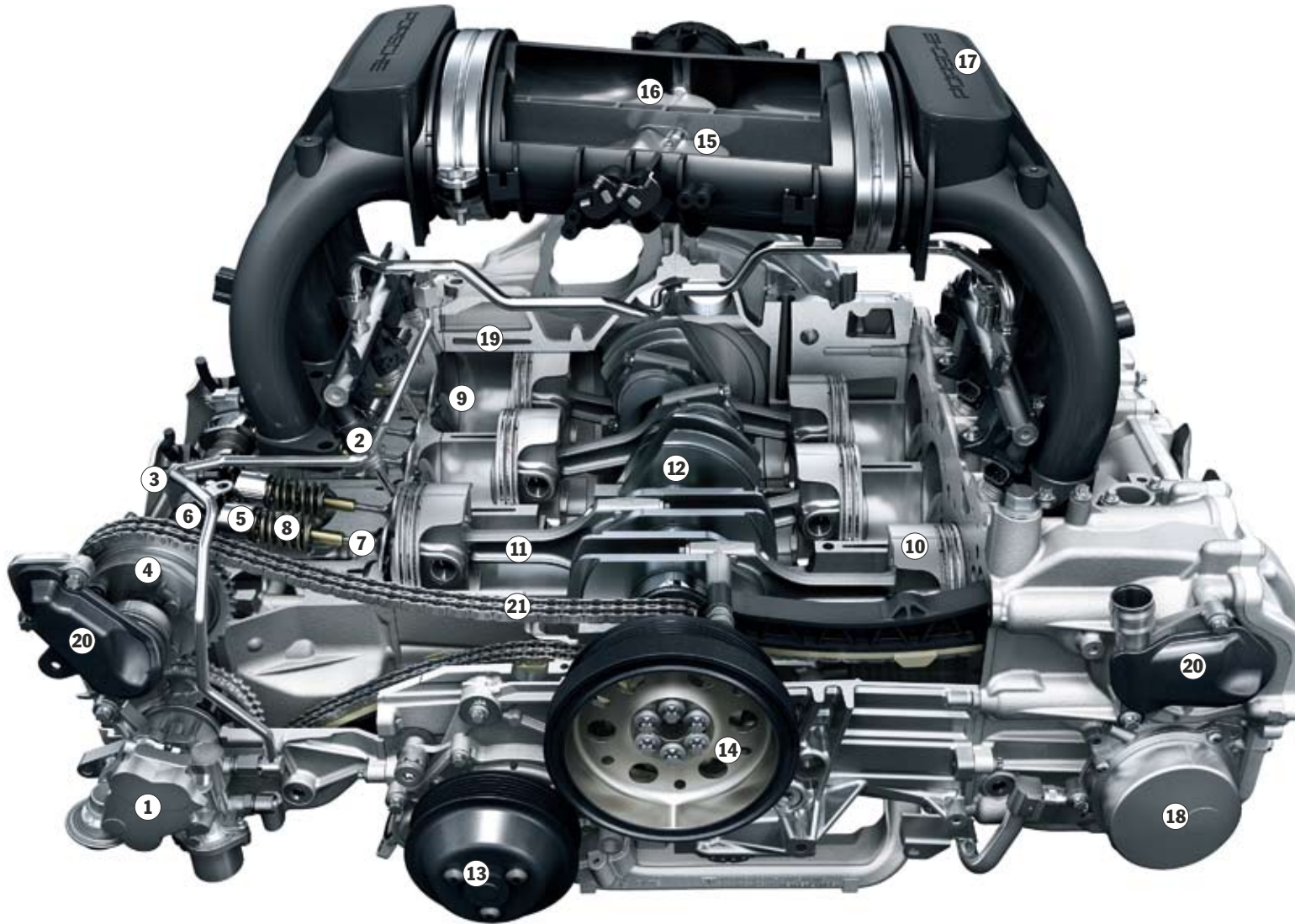

1. High-pressure pump
2. High-pressure injector
3. Ignition rod module
4. Camshaft controller
5. Switch tappet with integrated valve clearance compensation
6. Intake camshaft
7. Intake valves
8. Valve spring
9. Combustion chamber with Alusil cylinder liner surface
10. Forged aluminium piston
11. Forged connecting rod
12. Crankshaft
13. Water pump
14. Vibration damper
15. Resonance valve
16. Distribution pipe flap
17. Intake manifold with integrated sound chamber
18. Vacuum pump
19. Coolant jacket
20. Crankcase breather
21. Timing chain

3.4-litre flat-six engine of the Cayman S



Cayman

Lightweight construction.

Both Cayman models are equipped with alloy engines. The ingenious design, down to the finest detail, keeps the weight of the engines low and therefore reduces fuel consumption. One of the ways in which this lightweight

construction was achieved was by fully integrating the camshaft bearings into the cylinder heads.

Integrated dry-sump lubrication.

The purpose of integrated dry-sump lubrication is to guarantee a reliable oil supply while reducing engine temperatures, even in sportily driven cars. The oil reservoir is located inside the engine. Four oil pumps remove the oil

from the cylinder heads directly into the oil sump. A fifth pump in the oil sump directly supplies the lubricating points in the engine.

To reduce power loss and increase efficiency, an electronically controlled oil pump supplies the lubricating points inside the

engine as and when required. This means that the oil pump does not work so hard when there is less demand for lubrication. The benefits of this oil supply system include optimum efficiency combined with a reduction in both fuel consumption and CO₂ emissions.

For the engine, these detailed solutions mean a consistent supply of oil regardless of gravitational loads, even in the most demanding track conditions.



Cayman

Engine cooling system.

Our cross-flow cooling system, as used in motorsport, supplies each engine cylinder uniformly with coolant. Valves are thus protected against overload and premature wear, which minimises the engine's tendency to knock and optimises emissions and fuel consumption.

Engine management system with E-Gas.

The electronic engine management system ensures optimum engine performance at all times. It regulates all engine-related functions and assemblies (see diagram). The results: optimum performance and torque with reduced fuel consumption and emissions.

Another important function of the system is cylinder-specific knock control. Since the six cylinders never all work under exactly the

same conditions, they are monitored individually by the knock control. The ignition point is shifted individually, as and when necessary, to protect the cylinders and pistons at high engine speeds. The on-board diagnostics, which are compliant with European standards, ensure timely detection of any faults and defects that may occur in the exhaust and fuel systems and notify the driver immediately. This also prevents increased pollutant emissions and unnecessary fuel consumption.

Input data

- Engine speed (from crankshaft)
- Inlet camshaft phase angle
- Engine load
- Throttle-valve angle
- Lambda sensor signals
- Knock sensor signals
- Temperatures
 - Coolant
 - Intake air
 - Air in engine compartment
 - Engine oil
 - Ambient air
- Pressures
 - Engine oil
 - Fuel
 - Ambient air
- Vehicle speed
- Air-conditioning settings
- Accelerator pedal

Electronic engine management
ME 7.8/Cayman - SDI 3.1/Cayman S

Regulation/control of

- Ignition
- Manifold injection (Cayman)/ direct fuel injection (Cayman S)
- Idling via throttle valve and ignition
- Heating of Lambda sensors
- Fuel pump (Cayman)/ fuel pumps controlled on demand (Cayman S)
- Fuel-tank venting
- Camshaft position
- Valve lift switchover (VarioCam Plus)
- Secondary-air injection (Cayman)
- Engine fan
- Starter
- Continuously variable oil pump
- Fuel pressure (Cayman S)
- Throttle valve

CAN interface with driving dynamics control, transmission control, immobiliser, instrument cluster, climate control, SPORT button, SPORT PLUS button, sports exhaust system button, diagnostics, etc.



Two-stage resonance intake manifold.

The intake manifold with double-flow distributor pipe has an adjustable flap that closes and opens at defined engine speeds. As a result of a two-stage resonance effect, the air mass in the intake manifold begins to oscillate, which in turn generates a turbocharging effect and optimises induction. These two effects combine to produce higher torque at low engine speeds, a flatter torque curve and increased power output at high engine speeds, while the acoustic properties of the system are second to none. A sound that is typically Porsche.

VarioCam Plus.

VarioCam Plus combines variable valve timing with two-stage lift on the inlet side. This results in smoother running, better fuel economy and lower exhaust emissions. As well as greater top-end power and low-end torque.

This two-in-one engine concept seamlessly adapts in response to driver input. The result: instant acceleration and extremely smooth running.

The variation in intake timing is steplessly controlled by means of an electrohydraulic rotary vane adjuster at the head of the corresponding camshaft.

To improve throttle response during the warm-up phase, VarioCam Plus selects high valve lifts with retarded valve timing. In the middle and low load ranges, low valve lifts with advanced timing reduce fuel consumption and exhaust emissions. High valve lifts generate high torque and maximum output.

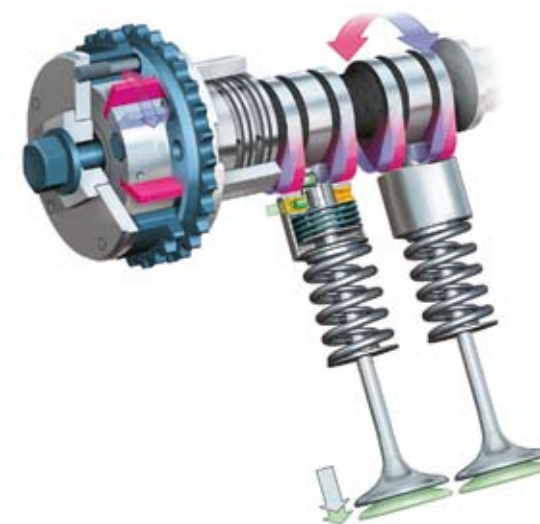

VarioCam Plus



Cayman S exhaust system



Cayman tailpipe



Cayman S twin tailpipes



Cayman S

Ignition system.

The ignition system is designed for static high-voltage distribution. Individual ignition coils on each of the spark plugs ensure perfect ignition every time. The individual ignition coils are controlled directly by the engine electronics.

Exhaust system.

The exhaust system – with twin tailpipes on the Cayman S – is made of stainless steel. Until it converges in the connecting tube, the exhaust gas is channelled through two separate tracts and, thanks to separate exhaust gas cleaning systems, the exhaust gas can flow more freely – for increased power and torque. The stereo Lambda control

circuitry controls and monitors each cylinder bank separately. For each exhaust tract, four corresponding oxygen sensors regulate the composition of the exhaust gas and monitor the conversion of pollutants in the catalytic converters.

A sports exhaust system – for a more resonant sound – is available as an option for each of the Cayman models.

Servicing.

It is a good idea to have your vehicle serviced regularly, but it makes just as much sense to keep the time between maintenance services as long as possible. Why? Because a Porsche belongs on the road, and not in the workshop.

The alternator, power-steering pump and the air-conditioning

compressor are all driven by a single self-adjusting belt. Hydraulic valve clearance compensation makes valve clearance adjustment unnecessary. The drive chains on the camshafts do not normally require servicing. With the sole exception of the spark plugs, the ignition system is also maintenance-free.

Put simply, we don't expect to see your Porsche too often.



- | | | |
|---|---|--------------------------|
| 1. Radiator module | 6. Resonance intake manifold | 11. Interconnecting tube |
| 2. Brake booster | 7. Coolant expansion tank | 12. Oil filler pipe |
| 3. Gear lever/gear selector | 8. Electronically controlled throttle valve | 13. Air cleaner snorkel |
| 4. PASM shock absorbers | 9. Connecting duct | |
| 5. 6-speed manual gearbox or 7-speed Porsche Doppelkupplung (PDK) | 10. Rear silencer | |

If you want to get straight to the point, you don't take any detours.

Transmission.

Porsche Doppelkupplung (PDK).

The optional Porsche Doppelkupplung (PDK), with both manual gearshift and an automatic mode, enables smooth gear changes with no interruption in the flow of power. This results in significantly faster acceleration and lower fuel consumption, without having to sacrifice the ease of automatic transmission.

In total, PDK has seven gears at its disposal. Gears 1 to 6 have a sports ratio and top speed is reached in 6th gear. The 7th gear has a long ratio and helps to reduce fuel consumption even further.

PDK is essentially two half gearboxes in one and thus requires two clutches – designed as a double wet clutch transmission.

This double clutch provides an alternating, non-positive connection between the two half gearboxes and the engine by means of two separate input shafts (input shaft 1 is nested inside the hollowed-out input shaft 2).

The flow of power from the engine is only ever transmitted through one half gearbox and one clutch at a time, while the next gear is

preselected in the second half gearbox. During a gear change, therefore, a conventional shift no longer takes place. Instead, one clutch simply opens and the other closes at the same time. Gear changes can therefore take place within milliseconds.

Clutch 1 controls the first half gearbox, which contains the odd gears (1, 3, 5, 7) and reverse. Clutch 2 controls the second, which contains the even gears (2, 4, 6).



Cayman S



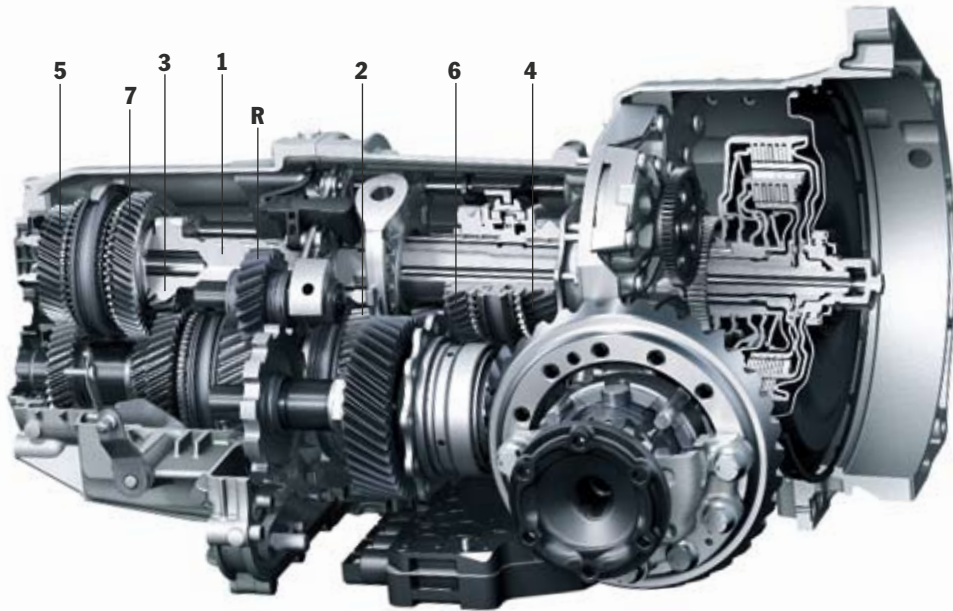

Porsche Doppelkupplung (PDK)

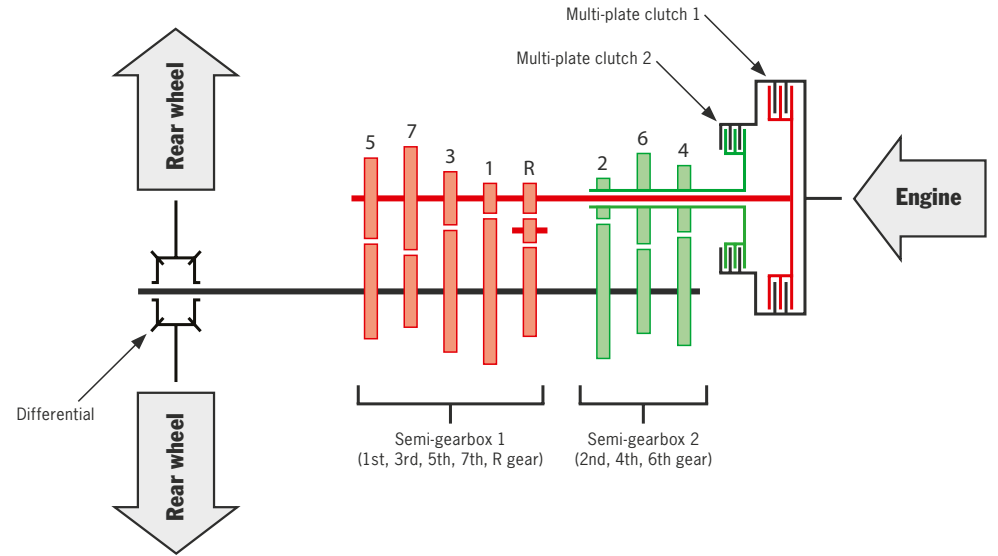

PDK function diagram

Porsche Doppelkupplung (PDK) in detail.

The crankshaft transmits engine torque to the dual-mass flywheel which is then channelled through the clutch housing and onto the multi-plate clutches, or to be more precise, the outer disc carrier.

Under oil pressure, clutch 1 closes and forms a frictional connection

with input shaft 1. The torque is now transmitted through the differential to the rear axle. At this stage, PDK has already preselected the next gear. Engine torque is already acting on the other outer disc carrier and, in response to a gear change signal, the overlap shift is initiated, i.e. as clutch 1 opens, clutch 2 closes. The non-positive connection with input shaft 2

is established, and power is transmitted to the wheels. The gear which is engaged is displayed on the instrument cluster. Depending on the gearshift programme, the gear change is optimised for comfort or for sporty handling and takes place in a matter of milliseconds. The advantages over a fully manual transmission are very

rapid gearshifts with no interruption in the flow of power, which result in a considerably faster rate of acceleration for the same rate of fuel consumption. The advantage over a fully automatic transmission is the perceptible increase in driving dynamics – with a similar level of comfort, and a distinct reduction in fuel consumption.

The compact dimensions of the gearbox reduce rotational masses which means that the engine response is more direct and the system is more lightweight. This, along with the long-ratio 7th gear, helps to achieve reduced fuel consumption and emission figures comparable with those of a manual gearbox. With the optional Sport Chrono Package,

PDK is enhanced by the ‘Launch Control’ and ‘motorsport-derived gearshift strategy’ functions (p. 62). In essence, PDK combines sportiness with efficiency and comfort. What does all this mean for you? Exactly what you would expect: uninterrupted driving pleasure.



Three-spoke sports steering wheel with gearshift switches



Three-spoke sports steering wheel with gearshift paddles



Gear selector for PDK



Gear lever in carbon

Three-spoke sports steering wheel with gearshift switches.

In conjunction with the optional Porsche Doppelkupplung (PDK), the standard three-spoke sports steering wheel has two ergonomic switches.

One press with the thumb and PDK shifts up. One pull with the index finger and PDK shifts down. When combined with one of the optional Sport Chrono packages (p. 62), there is an additional display above the airbag module. It tells you whether the SPORT, SPORT PLUS and Launch Control functions are activated.

Three-spoke sports steering wheel with gearshift paddles.

This optional steering wheel allows you to make motorsport-style gear changes. The gearshift paddles are made from a strong alloy and are ergonomically located behind the steering wheel spokes. Pull the right-hand paddle and PDK shifts up. Pull the left-hand paddle and PDK shifts down. Visually, the steering wheel is distinguished by its high-quality twin-spoke design and silver-coloured galvanised spoke cover. The airbag module is finished in the same colour as the steering wheel rim.

A display on the left and right steering wheel spokes tells you whether the SPORT, SPORT PLUS and Launch Control functions are activated. Another feature reminiscent of the world of motorsport is the top centre marking on the steering wheel rim.

Gear selector for Porsche Doppelkupplung (PDK).

The gear selector for PDK impresses not only with its unique design, but above all with its superior functionality enabling you to change gear manually: press

forwards to shift up, pull backwards to shift down.

Even if the gear selector is set to automatic mode, you can still change gear manually using the switches or gearshift paddles on the steering wheel.

Six-speed manual gearbox.

Fitted as standard in each of the Cayman models is a six-speed manual gearbox. The shift throw is short and precise, the tuning is sporty – as befits the character of the Cayman models. The dual-mass flywheel minimises engine noise

and the control cable mechanism prevents vibrations from being transmitted to the gear lever.

Hill-start assist.

Hill-start assist comes as standard for manual and Porsche Doppelkupplung (PDK) transmissions. It assists the driver in making a comfortable, smooth and roll-free start on an incline.

The system automatically detects that the vehicle has been braked to a halt on an incline. Provided a gear is engaged, the brake pressure is maintained at all four

wheels for approximately two seconds once the footbrake is released. The vehicle is therefore temporarily prevented from rolling backwards. Brake pressure is reduced if, within two seconds, sufficient revs have been generated by the driver depressing the accelerator pedal (or, in the case of manual transmission, the accelerator pedal is depressed and the clutch is engaged).



Chassis

**It's not always better
to take the direct route.**

If you have a spirited nature like the Cayman models, you will need a chassis that can cope with the challenges of the road ahead – and master them with precision. How is this achieved?

All components must be the perfect match. There's only one goal: to be able to fully express one's desire for performance.

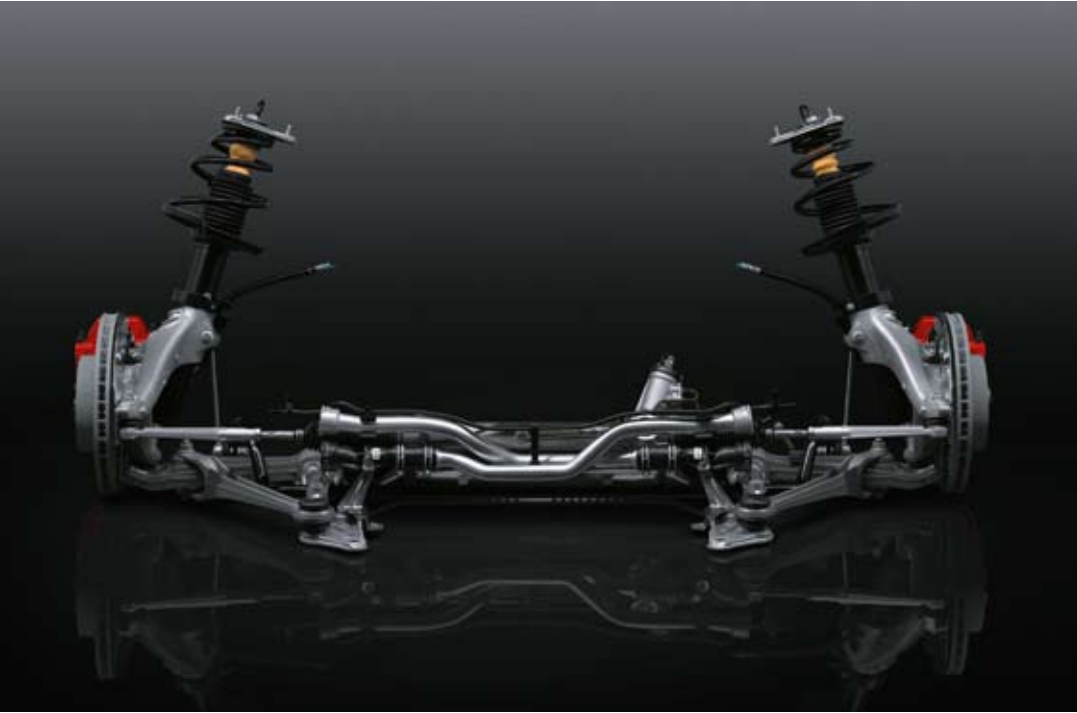

Lightweight spring-strut front axle on the Cayman S



Lightweight spring-strut rear axle on the Cayman S

An expression of agility on the road that is bound to leave you open-mouthed.

Chassis.

The Cayman models follow a clear line. Their own. Even when it comes to the chassis. The driver's connection to the road is an essential priority at all times,

along with the delivery of the engine's power.

For this reason, the Cayman models are equipped with a lightweight suspension with transverse links and spring

struts, front and rear. The spring and damper unit and the anti-roll bar unit have been tuned for exceptional driving dynamics combined with a high level of driving comfort. For Porsche, that is not a contradiction. During

fast lane changes and through tight corners, this chassis is in its element. Thanks to the mid-engine layout and the construction of the bodyshell, roll and pitch are practically eliminated. The chassis responds with absolute precision

to acceleration and braking. The lightweight construction keeps the vehicle gross weight and the weight of the unsprung masses low. Virtually all moving axle parts are made of aluminium.

Driving stability is excellent, even in the event of considerable load changes – thanks not least to the vehicle's generous track width. High levels of safety and a consistently dynamic driving experience are the result.

Steering.

What use is a perfect suspension setup without perfectly tuned steering? For Porsche, this would be inconceivable. The solution is a steering system that works with as much precision and immediacy as the chassis itself and, thanks to the power assistance, steering

effort is reduced to a comfortable level. Around the straight ahead position, such as during motorway driving, the ratio is less direct with no loss of agility or feedback. The greater the steering angle, the more direct the steering ratio. This is particularly noticeable through tight bends and when parking and provides a high

level of active safety and a more immediate driving response. The car has a turning circle of just 11.1 m. The steering wheel also adjusts for height and reach. For further details about available steering wheels, please see page 81.



Cayman S



Cayman S



17-inch Cayman II wheel



18-inch Cayman S II wheel

Wheels.

The Cayman is fitted with 17-inch wheels as standard. The star-shaped design expresses sheer sportiness and allows an eye-catching view of the brake calipers. The Cayman S is fitted with large, 18-inch wheels as standard and the turbine-like arrangement of the spokes gives the car an extremely powerful look. 19-inch wheels are available for both models on request. All available wheels are equipped

with anti-theft protection. A selection of alternative wheels, such as the 19-inch 911 Turbo II wheel, is featured on page 117.

Tyre Pressure Monitoring (TPM).

The optional Tyre Pressure Monitoring (TPM) sends warnings to the on-board computer's display screen in the event of low tyre pressure. The driver can check the pressure in all four tyres from the instrument cluster.

The system updates quickly and accurately after an engine start, tyre pressure correction or wheel change – for increased comfort and safety.

Porsche Active Suspension Management (PASM).

The optional PASM is an electronic damping control system. PASM actively and continuously regulates the damping force for each wheel according to the road conditions and driving style. In addition, the suspension is lowered by 10 mm.

The driver can select between two different modes: 'Normal' which is a blend of performance and comfort, and 'Sport' where the setup is much firmer. Depending on the mode selected, therefore, PASM is sportier or more comfortable than the standard chassis. The PASM control unit evaluates the driving conditions and modifies the damping force on each of the wheels in accordance with the selected mode.

Sensors monitor the movement of the vehicle body, for example, under heavy acceleration and braking or on uneven roads. The control unit tunes the dampers to the optimum hardness for the selected mode to reduce roll and pitch still further and to increase contact between each individual wheel and the road.

In 'Sport' mode, the suspension is set to a harder damper rating. On uneven roads, PASM immediately switches to a softer rating within the 'Sport' setup range, thereby improving contact between the wheels and the road. When the road surface improves, PASM automatically reverts to the original, harder rating.

If 'Normal' mode is selected and the driver's style becomes more assertive, PASM automatically switches to a harder rating within the 'Normal' setup range. Damping becomes harder, and driving stability and road safety are increased.

Mechanically locking rear differential.

Are you a fan of sporty driving? In your spare time, do you enjoy the occasional outing on the racetrack? Then you shouldn't do without the optional mechanically locking rear differential available in conjunction with 18-inch or 19-inch wheels. It further enhances the traction of the driven rear wheels on uneven roads and when accelerating out of tight bends, and the damping of load-change reactions during fast cornering is reduced. Road holding at the limits of performance is even more impressive. The car holds its course better and so PSM intervenes less often.

In other words, sheer driving pleasure and faster lap times.



Rebound in 'Normal' mode – working piston and bypass, sporty-comfortable tuning



Rebound in 'Sport' mode – working piston only, sporty-hard tuning



Compression in 'Normal' mode – working piston and bypass, sporty-comfortable tuning



Compression in 'Sport' mode – working piston only, sporty-hard tuning



Sport Chrono stopwatch

Sport Chrono Package.

Do you think driving a Porsche should be an even more involving experience than it is already? Your wish is our command. On request, we can equip your vehicle with the Sport Chrono Package, which is available for both of the Cayman models. Its functions enable even sportier tuning of the engine and chassis and guarantee even more driving pleasure.

Selecting the SPORT button on the centre console activates

‘Sport’ mode, which makes throttle response significantly more immediate, adjusts the rev-limiter to a harder setting, and tunes the engine dynamics for performance driving.

The optional Porsche Active Suspension Management (PASM) also switches to ‘Sport’ mode, which offers harder damping and more direct steering and, therefore, better road holding.

With the optional PDK in automatic mode, gearshift points are

delayed until the upper rev range. The shift times are shorter, the gear changes sportier. At low rates of deceleration, the system initiates a swifter, brake-induced downshift. In manual mode, gear changes are faster and more dynamic. In ‘Sport’ mode, the PSM system (p. 72) intervenes later for increased longitudinal and lateral dynamics. PSM now affords greater manoeuvrability under braking and exit acceleration, especially at low speeds.

For maximum dexterity, PSM can be set to standby while the car is still in ‘Sport’ mode (p. 72). For safety, it is set to intervene automatically only when ABS assistance is required on both front wheels.

A key component of the Sport Chrono Package is the swivel-mounted stopwatch in the centre of the dashboard with analogue and digital display.

In combination with Porsche Doppelkupplung (PDK), the Sport Chrono Package offers two additional functions that are activated by the SPORT PLUS button.

First, ‘Launch Control’, which ensures you achieve the fastest possible rate of acceleration from a standing start – on the racetrack, for example. ‘Launch Control’ is operated via the SPORT PLUS button with the ‘D’ or ‘M’ drive position selected. Whilst the driver depresses the brake pedal with the left foot, the right foot depresses the accelerator pedal to the floor. With the accelerator in the kickdown position, the

system detects the driver’s request for Launch mode and revs the engine to an optimum speed of approximately 6,500 rpm. Engine torque increases and the clutch closes slightly. The message ‘Launch Control’ appears on the display on the steering wheel for PDK. The driver now quickly releases the brake – and prepares for maximum acceleration.

Second, the ‘motorsport-derived gearshift strategy’. Using this, PDK is geared up for maximum shift speed, the shortest possible shift times and optimum shift points for maximum acceleration – for uncompromising performance.

Sport Chrono Package Plus.

On request, the optional Porsche Communication Management (PCM, p. 92) can be combined with the Sport Chrono Package Plus. In addition to the functions of the Sport Chrono Package, it includes a personal memory function, which can be controlled using PCM, and a performance display for evaluating lap times.



SPORT and SPORT PLUS buttons on the centre console



Three-spoke sports steering wheel with gearshift switches

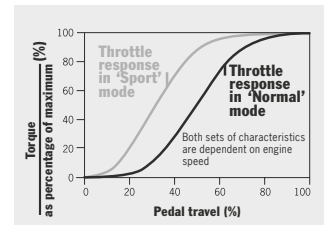

Comparison of the ETC characteristic curve in ‘Normal’ mode and ‘Sport’ mode



Safety

**A controlled offensive.
Even on the defensive.**

The Cayman models are uncompromising sportscars. In every respect. The same applies to safety. Active as well as passive. Trust alone is not enough.

You have to be confident about your vehicle. So we've taken care of it. Anything else just wouldn't be Porsche.

There can be no driving pleasure without peace of mind. Introducing the safety features of the Cayman models.

Active safety.

Active safety is a topic that Porsche actively supports. With generous safety margins, even the suspension tuning makes a decisive contribution. Optimum acceleration enables rapid overtaking and optimum braking minimises stopping distances. Safe contact with the road is provided not only by the wheel/tyre combination but also by the

auto-deploying bi-plane rear spoiler and aerodynamic front end. Another important standard safety feature is Porsche Stability Management (PSM, p. 72).

See and be seen. This is a slogan that typifies the headlights concept. The design is unmistakable, the brightness unmissable. The halogen headlights with LED position lights in the front light unit ensure clear visibility at all times.

The low front fog lights offer outstanding illumination and a high-level third brake light is neatly integrated into the rear window. LED technology is used in the taillights, brake lights and rear fog light to provide better illumination and respond more quickly to driver input.



Cayman S

Bi-Xenon headlights with dynamic cornering lights and LED daytime running lights.

Available as an option for the Cayman models are Bi-Xenon headlights including dynamic cornering lights and LED daytime running lights. Bi-Xenon headlights are around twice as powerful as halogen headlights so they offer improved visibility and illuminate the road more evenly. In fact, they are so effective that fog lights are no longer necessary. A headlight cleaning system is built-in.

Dynamic cornering lights offer particularly effective illumination of the road ahead, particularly through bends. Sensors continuously monitor the speed, lateral acceleration and steering lock and, from these variables, calculate the course of the bend. This determines the angle of the dynamic cornering lights, with the lights able to swivel towards the inside of the bend up to a limit of 15 degrees, even with the main beam switched on.



Night design, front



Night design, rear



Bi-Xenon headlights with dynamic cornering lights and LED daytime running lights



Braking system.

The acceleration of the Cayman models is impressive. Even more impressive, perhaps, is the vehicle's maximum braking power, which comfortably tames the power of the engine.

Four-piston aluminium monobloc brake calipers are fitted front and rear. Offering excellent rigidity, they are compact and save on weight. Their superior responsiveness, for fast and sensitive braking, sets them apart. A brake booster provides assistance, reducing pedal effort whilst maintaining a powerful braking effect.

A special ventilation system, whereby the entire wheel brake is supplied with cooling air by openings in the front end and special channelling systems, increases the stability of the brakes during heavy use.

The front axle of the Cayman and Cayman S features internally vented brake discs with a diameter of 318 mm. 299 mm brake discs are fitted to the rear axle. The result is outstanding braking performance. The rear brake discs of the Cayman S are 4 mm thicker than those of the Cayman, which increases stability under load even further. To distinguish them visually, the brake calipers on the Cayman have a black anodised finish while those on the Cayman S are painted red.

For reduced weight, optimum braking in the wet and improved cooling, the brake discs on both models are cross-drilled.

For the Cayman S, the Porsche Ceramic Composite Brake (PCCB) is available as an option.



Standard brake unit (Cayman)



Standard brake unit (Cayman S)



Porsche Ceramic Composite Brake (PCCB)



Cayman S with PCCB

Porsche Ceramic Composite Brake (PCCB).

On request, we can equip your Cayman S with a brake system that has already had to cope with the harshest requirements of motorsport: the Porsche Ceramic Composite Brake (PCCB). The ceramic brake discs have a diameter of 350 mm front and rear – for extremely powerful braking.

The brake discs are formed from a specially treated carbon-fibre compound that is silicated in a high-vacuum process at approximately 1,700 °C. Not only are the resulting discs much harder than standard discs, they are more resistant to heat. The low thermal expansion of the brake discs prevents deformation under heavy braking. Furthermore, the ceramic brake discs are totally resistant to

corrosion and offer more favourable noise-damping properties.

Six-piston aluminium monobloc fixed calipers on the front axle and four-piston units at the rear provide a high and constant brake pressure. The pedal response is fast and precise with only moderate input required.

All the necessary ingredients are there for a short braking distance, even in the toughest conditions. Moreover, safety under braking at high speeds is increased thanks to the excellent fade resistance of PCCB.

The key advantage of PCCB is that the brake discs are approximately 50% lighter than standard discs of similar design and size. A factor

that helps to reduce unsprung and rotating masses on the vehicle. The consequence of this is better road holding and increased comfort, particularly on uneven roads, as well as greater agility and improved handling.

Please note that circuit racing, trackday use and other forms of performance driving can significantly reduce the service life

of even the most durable brake pads and discs. We recommend that all brake components be professionally inspected and replaced where necessary after every track event.



Cayman

Porsche Stability Management (PSM).

PSM, which comes as standard, is an automatic control system that stabilises the vehicle at the limits of dynamic driving performance. Sensors continuously monitor driving direction, speed, yaw velocity and lateral acceleration. Using this information, PSM computes the actual direction of motion. If this direction deviates from the desired course, PSM initiates braking interventions targeted at individual wheels in order to stabilise the vehicle.

Under acceleration on wet or low-grip road surfaces, PSM improves traction using the ABD (automatic brake differential) and ASR (anti-slip regulation) functions, giving an agile response. When 'Sport' mode is selected on the optional Sport Chrono Packages (p. 62), the PSM intervention threshold is raised to enable greater driver involvement – particularly at speeds of up to approximately 70 km/h (45 mph). The integrated ABS can further reduce the braking distance. For an even sportier drive, PSM can be deactivated. However,

it is automatically reactivated for your safety if either of the front wheels (in 'Sport' mode, both of the front wheels) requires ABS assistance. ABD remains permanently active. Two additional functions of PSM increase safety even further: precharging of the brake system, and brake assist. If you suddenly release the accelerator pedal, PSM automatically readies the braking system. With the braking system having been precharged, the brake pads are already in light contact with the brake discs. Maximum braking power is therefore achieved much

sooner. When sudden braking is detected, the brake assist function applies maximum brake pressure to all four wheels.

Passive safety: engineered design.

The system of longitudinal and transverse members at the front of the vehicle (1) distributes the

forces exerted onto the bodyshell in the event of an impact and minimises deformation of the passenger cell. Our patented bodywork structure with a rigid bulkhead cross member (2) made of ultra high-strength steel absorbs the forces introduced into the system of longitudinal members which prevents deformation of the footwell. The reinforced doors (3) contribute to the overall

rigidity of the car. The forces exerted in a frontal collision are transmitted into the side structure along a higher load path (4), which improves the deformation characteristics of the passenger cell even further.

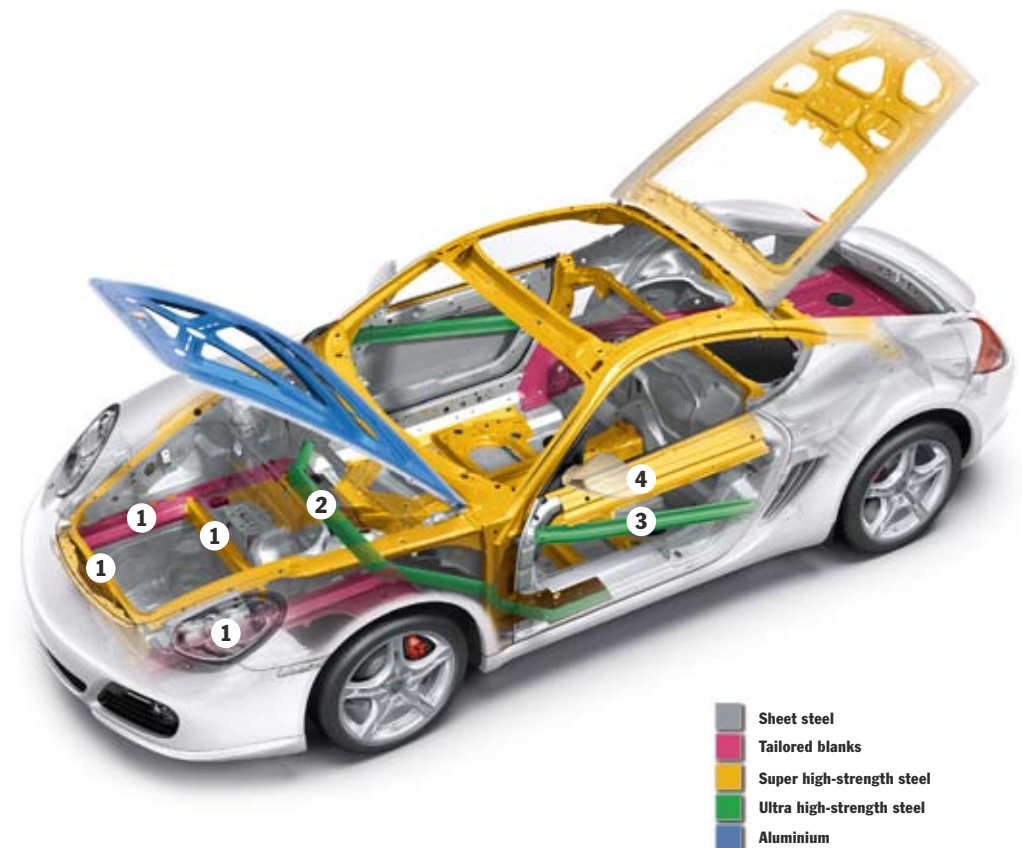

Passive safety: airbags.

Each of the full-size airbags is inflated in two stages, depending on the severity of an accident. In less serious accidents, the airbags are only partially inflated, thereby minimising discomfort for the occupants. Also fitted as standard is Porsche Side Impact Protection (POSIP). It comprises

side impact protection elements in the doors and two airbags on each side. An integral thorax airbag is located in the seat backrests, while each door panel contains a head airbag. With each having a volume of approximately 8 litres, these airbags offer excellent protection in the event of a side impact.

Other passive safety features include headrests integrated into the seat backrests, an energy absorbing steering column, three-point seat belts, front seat-belt pretensioners and force limiters, energy-absorbing elements in the dashboard and flame-resistant materials throughout the interior.



Cayman



Porsche Side Impact Protection (POSIP)

Anti-theft protection.

Both models are equipped with an immobiliser with in-key transponder. In addition, the Cayman S has an alarm system with contact-sensitive exterior protection as standard (optional for the Cayman). It is activated and deactivated by the remote control integrated in the ignition key, which is also used to lock and unlock the doors. Radar-based interior surveillance is available as an option for both models.

Vehicle tracking system.

In conjunction with the alarm system, this optional preparation enables future installation of a vehicle tracking system available from Porsche Tequipment. It makes it possible to locate a stolen vehicle across most of the countries of Europe. The package includes a special wiring loom and a higher-capacity battery. A tilt sensor for the alarm system is included.

Child seats.¹⁾

The child seat preparation package, which includes ISOFIX mounting points and a key switch for deactivating the passenger airbag, is available from Porsche Tequipment. A full range of child seats is also available from Porsche Tequipment.

¹⁾ Child seats must not be used with sports bucket seats.



Comfort

**This is not an ordinary sportscar.
But this doesn't mean it cannot be put to ordinary use.**

Just how much comfort can you expect from an uncompromising sportscar? A great deal. After all, if you want to express your personal

freedom, you should never have to feel constrained. It's a Porsche philosophy.

**What is a sportscar's greatest challenge?
Day-to-day practicality. Or so you'd think.**

Comfort in the Cayman models.

Not for Sunday drivers, yet built to be driven 365 days a year. It's a Porsche principle to which even the Cayman models have had to adhere. No wonder they

are regarded as an everyday sportscar. The low seat position, the dome-shaped roof and the large windows create an airy feeling of space. Seating comfort

is exemplary. The ergonomics are typically Porsche. Every control is within easy reach.

The CDR-30 audio system is just one of the many standard features you will find on the centre console. The luggage concept is also the result of the

ingenuity of our designers with a luggage compartment at the front and another spacious area under the rear lid.

In short, your Cayman has been designed with everyday enjoyment in mind. Ordinary enjoyment, however, would not be Porsche.



Cayman S interior with optional equipment, including sports bucket seats and personalised accessories from the Porsche Exclusive range



Cayman S dashboard with optional equipment, including PCM, cordless handset, Tyre Pressure Monitoring (TPM), Sport Chrono Package Plus and PDK

Instruments.

Each black circular dial in the instrument cluster – aluminium-coloured in the Cayman S model – provides important information at a glance. In the centre is the analogue rev counter with digital speedometer and a customisable display of key data from the

standard on-board computer. Additional data, such as average fuel consumption, fuel range or the data of the optional TPM can be shown as desired.

The right-hand dial displays a range of information, including the outside temperature and shift pattern of the optional Porsche

Doppelkupplung (PDK), as well as the selected gear. The dial on the left contains the analogue speedometer with digital trip meter and total distance display. The design and legibility of the dials are also enhanced by the white backlight illumination.

Steering wheels.

The Cayman models feature as standard a three-spoke sports steering wheel with full-size airbag. The steering wheel is adjustable for height and reach and the rim is in smooth-finish leather. As an option, you can specify a three-spoke multifunction steering wheel in leather with integrated buttons for the most essential

audio and, where applicable, navigation and telephone functions. Alternatively, the multifunction steering wheel is available in smooth-finish leather, Aluminium Look, carbon or macassar wood.

Fitted as standard in conjunction with Porsche Doppelkupplung (PDK) is the three-spoke sports steering wheel with gearshift switches. A multifunction version

of this steering wheel is offered as an option. Also available as an option is the three-spoke sports steering wheel with gearshift paddles (p. 52). For extra comfort on those cold days, steering wheel heating is available on request for all steering wheels (steering wheel heating available only in conjunction with heated seats).



Comfort seat with driver memory



Adaptive sports seat with driver memory



Sports bucket seat



Automatic climate control

Standard seats.

The standard seats with centre upholstered in Alcantara offer a high degree of comfort with good lateral support and optimised under-seat suspension. Through bends, your seat gives you a feeling of security without restriction. The seats are equipped as standard with manual height and fore/aft adjustment and an electric backrest adjustment, enabling virtually every driver to find the ideal seat position, regardless of physical build.

Comfort seats with driver memory.

Comfort seats with electric fore/aft, height, backrest and lumbar support adjustment are available as an option. The tilt angle of the

seat squab is also electrically adjustable. The memory function supports the exterior mirrors and all seat positions on the driver's side. Using the control switches in the door panel, it is possible to restore one of two personalised settings. Additionally, you can store a further seat position in each of the ignition keys. As soon as you unlock the door using the key remote, the driver's seat and exterior mirrors resume their stored position.

Sports seats.

The optional sports seats have firmer leather upholstery than the standard design. Higher side bolsters on the seat squab and backrest provide additional lateral support. The seat height and

fore/aft position is adjusted manually, the backrest electrically.

Adaptive sports seats with driver memory.

The optional adaptive sports seats in leather combine excellent comfort with first-rate track performance.

Along with all the adjustment features of the comfort seats, the side bolsters on the seat surface and backrest are individually electrically adjustable, for increased comfort on long journeys and tailor-made lateral support through bends or on the racetrack. The memory function supports the exterior mirrors and all driver's seat positions, apart from the side bolsters.

Sports bucket seats¹⁾.

For the ultimate sports experience, you could opt for sports bucket seats with a folding backrest, integral thorax airbag and manual fore/aft adjustment. The backrest shell is made from glass/carbon-fibre-reinforced plastic and has a stylish carbon-weave finish. The backrest pivots are positioned high in the side bolsters to provide lateral support to the pelvic region, characteristic of a race seat. The seat upholstery is offered in all available leather types and colours.

Seat heating and ventilation.

As an option, all compatible seats – apart from sports bucket seats – can be equipped with two-level seat heating.

Seat ventilation for the standard seats and comfort seats is also available as an option (only in conjunction with heated seats, climate control and part or full-leather interior). A slipstream effect evaporates perspiration moisture – for a comfortable seating environment. Ventilation intensity can be set to one of three levels.

Air conditioning.

Both Cayman models come with a powerful and quiet air-conditioning system as standard. The optional climate control system offers even more uniform and comfortable ventilation.

Cruise control.

This optional automatic speed controller for the 30 to 240 km/h (19–149 mph) speed range is operated using a switch on a separate control stalk on the steering column.

¹⁾ Child seats must not be used with sports bucket seats.



Rear screen

‘Welcome Home’ lighting.

When the vehicle is opened or closed using the key remote, the standard automatic locator lighting automatically switches on the fog lights and LED daytime running lights. This is particularly convenient at night. In conjunction with the optional PCM (p. 92) and Sport Chrono Package Plus (p. 63), the delayed lighting switch-off period can be adjusted as desired.

HomeLink® (programmable garage door opener).

The optional programmable garage door opener is integrated into the overhead console and remotely controls up to three different garage doors, gates, home lighting and/or alarm systems.

Water-repellent side windows.

The surfaces of the side windows are treated with a water-repellent coating so that not only water but also dirt runs away more easily, thereby providing optimum visibility even in poor weather.

Windscreen wipers.

The windscreen wipers with an adjustable intermittent wipe speed are aerodynamic and



Cayman with ParkAssist

inconspicuous. The windscreen washer system has two heated and filtered nozzles. An integrated rain sensor is available as an option (in conjunction with auto-dimming mirrors).

Rear screen.

The rear screen is tinted and has heating functionality. Its generous size affords excellent rearward visibility. A detachable fabric screen on the inside of the rear lid

provides additional privacy for the main luggage area.

Rear wiper.

The Cayman models can be equipped with an effective and streamlined rear wiper on request. It is styled to blend seamlessly into the overall design of the vehicle.

ParkAssist.

As soon as reverse gear is engaged, the optional ParkAssist is activated automatically. If you move too close to an obstacle, a warning signal begins to sound, becoming faster until the car stops. The sensors of the optional ParkAssist are neatly concealed in the rear bumper.



Cayman with matching luggage set from the Porsche Design Driver's Selection

Transport concept.

The Cayman models satisfy your need for independence, whatever your destination or purpose. After all, there are occasions when you don't get into your car merely for the sake of it. Sometimes, you simply need to get from A to B. Such as a trip to the shops, or to pursue your favourite leisure activities. With their generous

transport concept, which includes two luggage compartments, a wide range of storage spaces and the optional roof transport system, the Cayman models are extremely practical. And, of course, they still offer an abundance of driving pleasure, whatever the reason for your journey.

Front luggage compartment.

The front luggage compartment is lined with black carpet and offers 150 litres of loadspace.

Rear luggage space.

The luggage space located beneath the upholstered rear lid is lined with carpet in the interior colour and consists of both a

storage surface above the engine cover and the luggage compartment behind it. This design enables the convenient loading of longer items of luggage. It has a capacity of 260 litres and a high-quality finish. On request, you can have the panels surrounding the engine cover and the integral strut tower mouldings finished in the vehicle's exterior colour.



Front luggage compartment

A retaining rail at the front of the engine cover helps to secure any luggage under braking. A luggage stop behind the seats is also available as an option. Smaller items can be secured on top of the engine cover using a luggage net with four lashing eyelets. A stainless steel partition provides an elegant transition to the lower rear luggage area. This is the ideal space for larger items and also has four lashing eyelets for attaching a luggage net.



Rear luggage space

Another useful feature is the covered service opening, which conceals the conveniently located coolant and engine oil filler tubes.



Luggage stop



Rear luggage space

Storage compartments.

The interior of the Cayman models is packed with a wide range of ingenious and ergonomically positioned storage spaces. On the passenger's side, there is a large, lockable glove compartment, which will contain integral CD storage if you have selected an optional sound system. Other storage compartments can be found beneath the radio or PCM, in the rear centre console and in the door armrests. In the Cayman S, the lids of these compartments are trimmed in leather. Between the two seats, on the engine bulkhead, is another compartment offering 4.5 litres of storage space. The dashboard trim strip neatly conceals two separate cup holders.



Door compartment



Lockable glove compartment



Cup holder

Roof transport system.

The optional roof transport system is aerodynamically efficient and made of aluminium. Its low weight and uncomplicated mechanism make it easy to fit. A range of

attachments are available for the roof transport system, such as a roof box and carriers for bikes and skis/snowboards – for sporty activities 365 days a year. The maximum permissible roof load is 60 kg. The preparation for

mounting the roof transport system is fitted as standard, while attachments are available from Porsche Tequipment through your Porsche Centre.



Cayman roof transport system

When you're driving along with bells and whistles, why not listen to some music, too?

Porsche audio and communication systems.

Admittedly, to outperform the distinctively powerful Porsche sound is a real challenge. Nevertheless, we've tried and have developed audio systems that offer a genuine alternative.

CDR-30 audio system.

Both Cayman models are equipped as standard with the CDR-30 audio system with a 5-inch display (monochrome) and an MP3-compatible CD drive.

An integrated six-disc CD/DVD autochanger is available as an option.

The FM dual tuner with RDS diversity, a total of 30 memory presets, dynamic autostore and speed-sensitive volume control are, as usual, all part of the standard package. Just like the high-quality sound, which is delivered by two high-range speakers in the dashboard, two low/mid-range speakers in the door trims and two 25-watt

output stages. For an even more impressive sound experience, you could opt for the Sound Package Plus or BOSE® Surround Sound System.

Controlling the CDR-30 could not be more simple: the function keys ensure that all the main functions are directly at your fingertips, and it is possible to conveniently control all of the most important functions using the buttons on any of the optional multifunction steering wheels.



CDR-30 audio system

**No time for instruction manuals?
We thought as much.**

**Porsche Communication Management (PCM)
including navigation module.**

As the central control unit for audio, navigation and communications, the optional PCM is multifunctional and ergonomic to operate.

The main feature is the 6.5-inch colour touchscreen with a durable, easy-to-clean coating. Functional, innovative and easy to use, you will find the display very clearly presented and a maximum of five list entries per page enable you to operate the unit quickly and safely. Alternatively, you can choose to operate the PCM using the rotary pushbutton on the right.

Radio functions include up to 42 memory presets and an FM dual tuner frequency diversity with RDS, which continuously scans in the background for the best signal. The integrated single CD/DVD drive supports the MP3 format and – in combination with the optional BOSE® Surround Sound System – is able to play back music from audio and video DVDs in 5.1 digital format. An integrated six-disc CD/DVD autochanger with MP3 playback is also available as an option for PCM.

Navigation module for PCM.

The GPS navigation system included with the optional PCM has an internal hard drive containing maps for most European countries. A touchscreen enables rapid destination input and instant viewing of traffic information and points of interest (POIs) by simply allowing you to touch the symbols on the map. Route diversions, e.g. the nearest service stations, can therefore be incorporated quickly and easily into the current route guidance.



Porsche Communication Management (PCM)

When viewing a map, it is possible to select between a 3D perspective and the 2D display. At motorway exits, graphical turn indications are displayed for better orientation. In splitscreen mode, you can choose to display not only the current map overview, but also a list of icons that represent dynamic route guidance.



3D map view with turn notification



2D map view

Electronic logbook for PCM.

The optional electronic logbook enables automatic recording of relevant driving data. Once you have downloaded the logbooks via Bluetooth® or the optional USB interface, you can evaluate them on your home PC using

the software supplied (software complies with all statutory requirements for automatic logbooks as specified by the German revenue authorities).

TV tuner for PCM.

The TV tuner, available on request, is capable of receiving free-to-air analogue and digital television broadcasts (DVB-T) to provide entertainment between journeys. For your safety, the TV picture is switched off while the car is in motion.

Voice control system for PCM.

Almost all of the functions of PCM can be controlled using the optional voice control system with word-by-word input. The menu item is read aloud exactly as it is displayed on the screen and the voice control system recognises commands or sequences of numbers, whoever the speaker. It then gives an audible acknowledgement and carries out the functions you request. There is no need to 'train' the system.

Telephone module for PCM.¹⁾

Available as an option, the GSM telephone module offers convenience and excellent reception. By inserting a SIM card directly into PCM's integral SIM card reader, calls can be made using the hands-free facility. For even more convenience, the Bluetooth® capability of a mobile phone can be used to make calls through the SIM Access Profile (SAP). Once automatic pairing is complete, the mobile phone's aerial is switched off to conserve battery charge and the phone operates via the car aerial. Depending on the type of mobile phone, this gives access not only to the numbers on the SIM card, but also to the phone's internal memory. A selection of mobile phones can be controlled entirely using PCM, the optional multifunction steering wheel or the optional voice control system without the phone ever leaving your pocket.

In addition, the telephone module enables you to establish a Bluetooth® link with those mobile phones that only support the Handsfree Profile (HFP). In this case, the GSM connection is always established through

the aerial of the mobile phone. PCM then acts as a hands-free system and you can leave the mobile phone tucked away.

On request, a cordless handset for the telephone module is also available. However, the handset cannot be used for Bluetooth® links established using the Hands-free Profile (HFP).

Mobile phone preparation for PCM and CDR-30.¹⁾

To enable a Bluetooth® connection for those mobile phones that only support the Handsfree Profile (HFP), an optional mobile phone preparation is available. With HFP, PCM or CDR-30 acts merely as a hands-free system. Here, too, you can leave the mobile phone tucked away in your pocket. However, PCM or CDR-30 is able to control only the basic functions of the mobile phone.

The GSM connection is established through the aerial of the mobile phone. The mobile phone preparation is available with or without a mounting bracket.

Universal audio interface for PCM and CDR-30.

With this optional feature, the storage compartment in the centre console will, in conjunction with the optional PCM, contain up to three connections: one for your iPod®, one for a USB stick/MP3 player and one as an AUX interface for any compatible audio source of your choice. The iPod® or USB stick can be controlled conveniently and safely using PCM. Through the USB socket, it is also possible to download data from the performance display of the Sport Chrono Package Plus, as well as data from the electronic logbook.

In conjunction with the CDR-30 audio system that comes as standard, the optional universal audio interface features an AUX socket for connecting any other type of audio source.

Sound Package Plus for PCM and CDR-30.

For sophisticated ears: the optionally available Sound Package Plus. With a total output

of 235 watts, a total of nine speakers combine to create the perfect interior sound experience.

Sound settings can be customised using the CDR-30 audio system or the optional Porsche Communication Management (PCM, p. 92). Also includes CD storage in the glove compartment.

CD or CD/DVD autochanger.

An integrated six-disc CD autochanger is available for the CDR-30 audio system on request. An integrated six-disc CD/DVD autochanger is also available for the optional PCM (Audio DVD playback only in conjunction with PCM). Both autochangers support the playback of audio tracks in MP3 format. They hold up to six CDs or DVDs and are easy to load by simply inserting the discs into the slot on the CDR-30 or PCM.

¹⁾Please see the notes on p. 124.

BOSE® Surround Sound System for PCM and CDR-30.

The optional BOSE® Surround Sound System is compatible with both the CDR-30 audio system, which comes as standard, and the optionally available PCM. Developed specifically for Porsche, it has been optimised for the Cayman models. A total of 10 loudspeakers, including an active subwoofer and central speaker, and a seven-channel digital amplifier with a total output of 385 watts, combine to produce a truly memorable sound experience.

During audio playback from audio or video DVDs (only in conjunction with the optional PCM), the system is able to make full use of the impressive sound spectrum of 5.1 digital recordings. With music in 5.1 digital format, the sound has already been recorded in a multi-channel format and is faithfully reproduced exactly as the original.

Five dedicated audio channels (front left, front right, centre, surround left, surround right) deliver a sound that is as authentic as it is natural. The digital 5.1 surround sound is balanced, lifelike and crystal clear. It's a sound that's as true to a live performance or cinematic experience as you can get.

Of course, you can still play traditional music sources such as CDs (only format supported by CDR-30), either in stereo or in one of the surround modes generated by the patented BOSE® Centerpoint® system. The algorithm of Centerpoint® II extracts an even more precise and realistic sound from the stereo signal.

The SurroundStage® signal processing circuitry developed by BOSE® assigns each individual audio channel, whether sourced from a DVD or generated by Centerpoint®, to a selected combination of loudspeakers and is therefore able to deliver an optimally balanced surround sound experience to both seat positions.

To complement these features, the BOSE® Surround Sound System offers a comprehensive selection of equaliser presets for customised sound. The dynamic loudness function increases bass levels as you decrease the volume, thereby compensating for the decreasing sensitivity of the human ear at these frequencies. Moreover, the AudioPilot® Noise Compensation Technology uses a microphone to continuously measure the ambient noise inside the vehicle and adapts music playback automatically so that a consistent sound is maintained in all driving conditions.

The BOSE® Surround Sound System. A genuine – perhaps the only – alternative to the characteristic engine sound.



7.0 cm centre speaker



Active subwoofer, 10.2 cm x 15.3 cm bass speaker in the passenger footwell



8.0 cm neodymium mid-range speaker and 20.0 cm Nd® bass speaker¹⁾

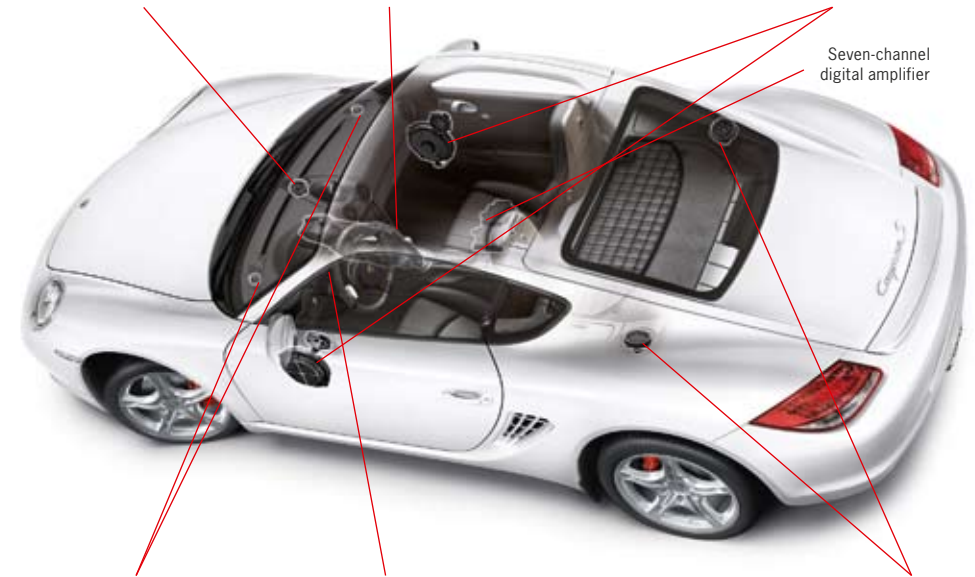

Seven-channel digital amplifier



2.5 cm neodymium tweeter



Microphone for AudioPilot® on the steering column



8.0 cm neodymium mid-range speaker

¹⁾Neodymium subwoofer with BOSE® patented technology for an extremely slim design and superior bass performance.



Environment

**It's not only technology that can be forward-looking.
Attitudes can be, too.**

The Cayman models exude character. They are strong-willed, unyielding, but never disagreeable. It shows in their attitude, especially towards the environment.

Resolute compliance with environmental regulations is the law they follow. As do all Porsche models. Because efficiency, too, is a question of character.

Top marks for cleanliness.

In an era of intensifying debate about global climate change and CO₂ emissions, every automotive manufacturer is asking itself what it has to offer in terms of environmental protection. Our answer has long been the same: maximum efficiency.

Over the last 15 years, Porsche has managed to reduce the fuel consumption of its vehicles by an average of 1.7% each year. Improvements in fuel economy also have a beneficial impact on CO₂ emissions. In relation to power output (g/km per hp), Porsche is already among those manufacturers achieving the lowest CO₂ emissions. This has been achieved through an efficient drive concept (DFI), lightweight construction, optimum aerodynamics and low rolling resistance.

This high level of environmental responsibility is clearly demonstrated by our approach to environmental management at the Porsche development centre in Weissach. Here, all technological developments are carried out with environmental protection in mind. The goal? Pure performance – but not at the expense of the environment. A goal achieved by the Cayman models.

Exhaust emission control.

Both engines comply with stringent emission standards, including Euro 5 in Europe and LEV II/ULEV in the USA. Vehicles manufactured by Porsche demonstrate that even high-performance sportscars can achieve moderate emission values in their respective category.

In short, the Cayman is not only extremely sporty, it is also very clean.

This attribute is achieved by means of a two-stage cascade-type catalytic converter which comprises two monolith substrates on each of the twin exhaust tracts. These specially coated substrates contain ultra-fine honeycomb channels in which pollutants are converted as exhaust gas passes through. The stereo Lambda control circuitry controls and monitors each cylinder bank separately, while another Lambda sensor on each cylinder bank monitors pollutant conversion in the respective catalytic converter (p. 44).¹⁾

¹⁾Not in markets with leaded fuel.

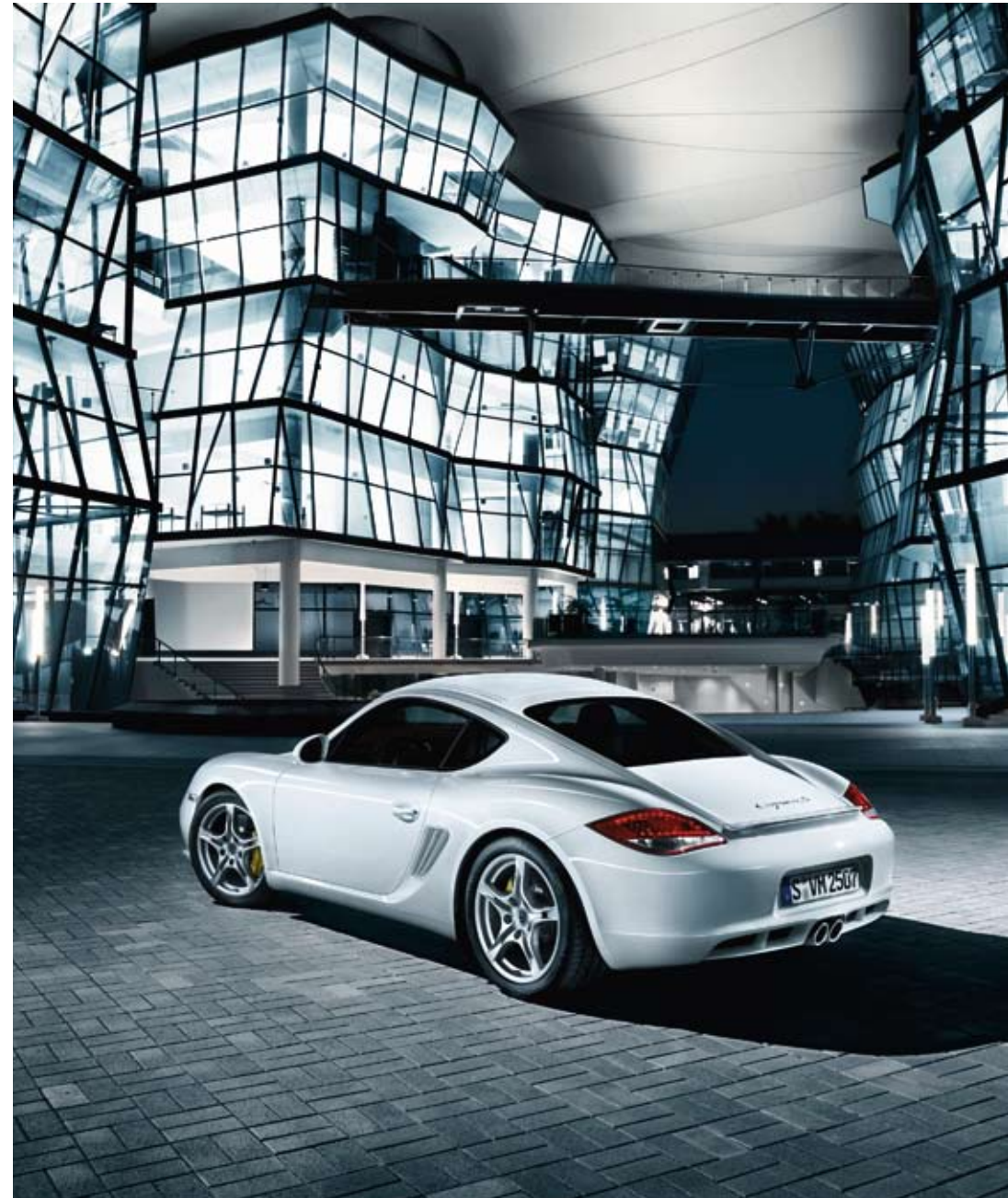



Fuel economy and recycling.

At Porsche, a fundamental aspect of design is intelligent lightweight construction. For both economical and ecological reasons. This forms the basis for low fuel consumption values in conjunction with outstanding performance.

It is economical thanks to the high proportion of aluminium cast alloys, plastics and super high-strength sheet steel used. This is substantially lighter and more stable than conventional steel. In the Cayman models approximately 20% of components are made from lightweight alloys. We use only innovative and environmentally friendly components, and each material is labelled to facilitate its separation for recycling. Recycled plastics are used where they meet exacting technical requirements. In all, the Cayman models are approximately 95% recyclable.

In addition, Porsche uses only environmentally friendly water-based paints. The Cayman is absolutely free of asbestos, CFCs and components manufactured using CFCs. This is because, here at Porsche, environmental protection does not begin at the end of a vehicle's life. It starts at the planning and development stage.

Fuel.

The Cayman models are already designed to operate on fuels with an ethanol content of up to 10%. Ethanol has a positive impact on the CO₂ balance since the plants cultivated for the production of this biofuel also absorb CO₂ from the atmosphere.

The active carbon filter and a special coating on the fuel tank reduce the amount of hydrocarbons released from the fuel system. All fuel lines are made of aluminium, while vapour-carrying lines are made from multi-layered plastic.

Noise.

The Cayman models comply with all applicable noise regulations without any form of engine encapsulation. To achieve this, noises are eliminated at source. Engine parts are stiff, moving parts are lightweight and tolerances are kept to a minimum. Large-volume silencers and resonators in the air intake system minimise noise further. For the entire service life of the vehicle.

Servicing.

Long service intervals offer clear advantages. For you: lower costs and saved time. For the environment: the use of fewer consumables and replacement parts. For full details of service intervals, please refer to the separate price list.



Personalisation

**We build you the sports car.
The rest is up to you.**

Admittedly, the Cayman models are already a declaration of individuality. But they're unable to express your individuality until you've given them your personal

touch. Using the wide range of available personalisation options for inspiration, you can lend your Cayman model a very special kind of style: your own.



Cayman S with interior package in Stone Grey leather

**The product of good taste.
Anything else simply won't do.**

Personalisation options.

No rules. No restrictions.
Do you share that philosophy?
We thought so. How you customise

your Cayman is well and truly in your
own hands. And so it should be.

The following pages feature a wide
selection of products, all arranged

into convenient categories. For
more information on the options
featured in this catalogue, please
refer to the separate price list.
These are not the only ways to style

your Cayman model to your
personal preference. With the
Porsche Exclusive range, you can
have your car prepared exactly
the way you want it. Turn something

special into something unique. Of
course, you can always personalise
your Porsche at a later time with
our Porsche Tequipment range of
accessories.

Colours.

When it comes to individual
style, one of the most important
considerations is your choice of
colour.

Available for selection are four
solid colours, eight metallic
colours, four special colours and
ten interior colours including
a two-tone leather package –
a combination of Black and
Stone Grey.

Of course, you can choose to
have your Cayman or Cayman S
finished in virtually any other
colour of your choice. It's just a
case of what takes your fancy.
For further information, please
refer to the Porsche Exclusive
Cayman catalogue.

Using the Porsche Car Configura-
tor at www.porsche.com, you can
transform your ideas into reality.
Here, you can design your very
own Cayman or Cayman S from
the ground up. The choice of
colour or additional equipment,
as always, is up to you.



Solid exterior colours.

Metallic exterior colours.

Special exterior colours.



Black

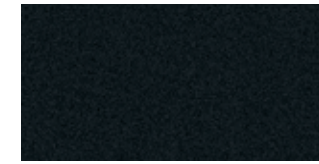

Basalt Black Metallic



Macadamia Metallic

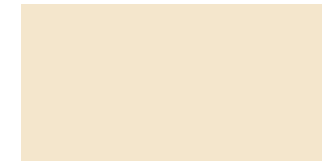

Cream White



Guards Red



Platinum Silver Metallic¹⁾



Meteor Grey Metallic

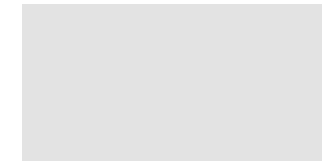

GT Silver Metallic

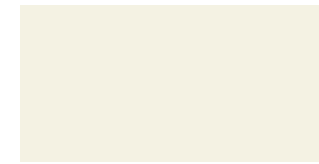

Carrara White



Dark Blue Metallic



Aqua Blue Metallic



Amethyst Metallic¹⁾



Speed Yellow



Ice Blue Metallic¹⁾



Porsche Racing Green Metallic



Ruby Red Metallic

¹⁾ Available from 09/10 at the earliest.
Also available up to 07/10: Arctic Silver Metallic (metallic exterior colour), Atlas Grey Metallic (special exterior colour).

Standard interior colours.

**Interior colours:
Alcantara/leatherette/
leather/soft-touch paint.**

Carpet.

Rooflining.



Black¹⁾



Black



Black



Stone Grey¹⁾



Stone Grey



Volcano Grey⁴⁾



Sand Beige¹⁾



Sand Beige



Sand Beige



Ocean Blue¹⁾



Ocean Blue



Volcano Grey⁴⁾

See separate price list for recommended colour combinations.

¹⁾ Soft-touch paint in interior colour; sun visors and inner door sill guards with film finish in interior colour.
²⁾ Interior in special colour, natural leather interior in Brown and Carrera Red: soft-touch paint in interior colour; sun visors and inner door sill guards with black film finish.
³⁾ Natural leather interior in Dark Grey: soft-touch paint in black; sun visors and inner door sill guards with black film finish.
⁴⁾ In conjunction with Alcantara: rooflining in Steel Grey.

Special interior colours.

**Interior colours:
leather/soft-touch paint.**

Carpet.

Rooflining.



Special colour: Terracotta²⁾



Terracotta



Black



Special colour: Cocoa²⁾



Cocoa



Black



Two-tone (Black and Stone Grey)



Stone Grey



Volcano Grey⁴⁾



Natural leather in Dark Grey³⁾



Dark Grey Natural



Volcano Grey⁴⁾



Natural leather in Brown²⁾



Natural Brown



Black



Natural leather in Carrera Red²⁾



Carrera Red



Black



Bi-Xenon headlights with dynamic cornering lights and LED daytime running lights

Exterior.	Cayman	Cayman S	I no.	Page
Option				
• Metallic paint	○	○	Code	109
• Special colours	○	○	Code	110
• Colour to sample	○	○	Code	
• Bi-Xenon headlights with dynamic cornering lights and LED daytime running lights	○	○	P75	67, 114
• Deletion of model designation	A	A	498	

The vehicles illustrated in the chapter on personalisation may include additional options not featured in this catalogue. For information on these options, please consult your Porsche Centre. For more information on the options featured in this catalogue, please refer to the separate price list. – not available ○ extra-cost option ● standard equipment A available at no extra cost



Roof transport system with roof box

Exterior.	Cayman	Cayman S	I no.	Page
Option				
• ParkAssist (parking aid at rear)	○	○	635	85
• Cayman Aerokit	○	○	XAM	127
• Rear wiper	○	○	425	85
• Windscreen with grey top-tint	○	○	567	
• Auto-dimming interior/exterior mirrors with integrated rain sensor	○	○	P12	85
• Roof transport system (basic load carrier)	○	○	549	89, 115



17-inch Boxster III wheel



18-inch Boxster S II wheel



19-inch Carrera Classic wheel



19-inch SportDesign wheel



19-inch Carrera Sport wheel



18-inch Cayman S II wheel



19-inch Carrera S II wheel



19-inch 911 Turbo wheel



19-inch 911 Turbo II wheel

Engine, transmission and chassis.

Option			I no.	Page
	Cayman	Cayman S		
• Porsche Doppelkupplung (PDK, 7-speed)	○	○	250	48
• Porsche Ceramic Composite Brake (PCCB)	—	○	450	70
• Porsche Active Suspension Management (PASM) with ride height lowered by 10 mm	○	○	475	60
• Mechanically locking rear differential (only in conjunction with 18-inch or 19-inch wheels)	○	○	220	60
• Sport Chrono Package	○	○	639	62
• Sport Chrono Package Plus (only in conjunction with PCM)	○	○	640	63
• Sports exhaust system	○	○	XLF	44

The vehicles illustrated in the chapter on personalisation may include additional options not featured in this catalogue. For information on these options, please consult your Porsche Centre. For more information on the options featured in this catalogue, please refer to the separate price list. — not available ○ extra-cost option ● standard equipment A available at no extra cost

Wheels.

Option			I no.	Page
	Cayman	Cayman S		
• 17-inch Boxster III wheels	○	—	394	59, 116
• 18-inch Cayman S II wheels	○	●	409	59, 116
• 18-inch Boxster S II wheels	○	○	408	59, 116
• 19-inch Carrera S II wheels	○	○	419	59, 116
• 19-inch Carrera Classic wheels	○	○	405	59, 117
• 19-inch SportDesign wheels	○	○	407	59, 117
• 19-inch Carrera Sport wheels ¹⁾	○	○	XRR	59, 117
• 19-inch 911 Turbo wheels	○	○	404	59, 117
• 19-inch 911 Turbo II wheels	○	○	421	59, 117
• Wheel centres with full-colour Porsche Crest	○	○	446	117
• Tyre Pressure Monitoring (TPM)	○	○	482	59

¹⁾ Includes wheel centres with full-colour Porsche Crest.



Rooflining in Alcantara



Sports seat



Luggage stop

Interior.			I no.	Page
	Cayman	Cayman S		
Option				
• HomeLink® (programmable garage door opener)	○	○	608	84
• Cruise control	○	○	454	83
• InteriorDesign package, painted	○	○	805	
• Automatic climate control	○	○	573	83
• Alarm system with interior surveillance	○	–	534	75
• Interior surveillance	–	○	534	75
• Preparation for vehicle tracking system	○	○	674	75
• Rooflining in Alcantara	○	○	594	118

Interior.			I no.	Page
	Cayman	Cayman S		
Option				
• Comfort seats with driver memory	○	○	P15	82
• Sports seats	○	○	P77	82, 119
• Adaptive sports seats with driver memory	○	○	P01	82
• Sports bucket seats	○	○	P03	83
• Seat heating	○	○	342	83
• Seat ventilation (only in conjunction with seat heating)	○	○	541	83
• Heated steering wheel (only in conjunction with seat heating)	○	○	345	81
• Luggage stop	○	○	580	87, 119
• Fire extinguisher	○	○	509	
• Floor mats	○	○	810	

The vehicles illustrated in the chapter on personalisation may include additional options not featured in this catalogue. For information on these options, please consult your Porsche Centre. For more information on the options featured in this catalogue, please refer to the separate price list. – not available ○ extra-cost option ● standard equipment A available at no extra cost



Soft ruffled leather seat



Three-spoke multifunction steering wheel



Natural leather interior with other optional equipment



Three-spoke sports steering wheel with gearshift paddles

Interior: leather and natural leather.

	Cayman	Cayman S	I no.	Page
Option				
• Partial leather seats	○	○	946	
• Soft ruffled leather seats (only in conjunction with leather interior)	○	○	982	120
• Leather interior package (includes seats, dashboard upper/lower sections and door panels in smooth-finish leather)				
– in standard colour	○	○	Code	
– in special colour	○	○	Code	
– in two-tone combination	○	○	970	
– in natural leather	○	○	998	78, 80
– in colour to sample	○	○	Code	

Interior: leather and natural leather.

	Cayman	Cayman S	I no.	Page
Option				
• Three-spoke multifunction steering wheel	○	○	844	81, 120
• Three-spoke sports steering wheel with gearshift paddles	○	○	840	52, 121

The vehicles illustrated in the chapter on personalisation may include additional options not featured in this catalogue. For information on these options, please consult your Porsche Centre. For more information on the options featured in this catalogue, please refer to the separate price list. – not available ○ extra-cost option ● standard equipment A available at no extra cost



Macassar interior package, three-spoke multifunction steering wheel in macassar and personalisation options from the Porsche Exclusive range

Interior: macassar dark wood (satin-matt).	Cayman	Cayman S	I no.	Page
Option				
• Macassar interior package ¹⁾	<input type="radio"/>	<input type="radio"/>	801	122
• Three-spoke multifunction steering wheel in macassar ¹⁾	<input type="radio"/>	<input type="radio"/>	847	122



Carbon interior package, three-spoke multifunction steering wheel in carbon and personalisation options from the Porsche Exclusive range

Interior: carbon.	Cayman	Cayman S	I no.	Page
Option				
• Carbon interior package	<input type="radio"/>	<input type="radio"/>	803	123
• Three-spoke multifunction steering wheel in carbon	<input type="radio"/>	<input type="radio"/>	845	123

¹⁾ Since wood is a natural product, there may be variations in colour and grain.

The vehicles illustrated in the chapter on personalisation may include additional options not featured in this catalogue. For information on these options, please consult your Porsche Centre.
For more information on the options featured in this catalogue, please refer to the separate price list.
– not available ◦ extra-cost option • standard equipment A available at no extra cost



Three-spoke multifunction steering wheel in Aluminium Look and personalisation options from the Porsche Exclusive range

	Cayman	Cayman S		
Interior: Aluminium Look/aluminium.				
Option			I no.	Page
• Three-spoke multifunction steering wheel in Aluminium Look	○	○	XPU	124
• Gear and handbrake levers in aluminium I	○	○	ECA	124
• PDK gear selector and handbrake lever in aluminium	○	○	ECB	

¹⁾ May be incompatible with some copy-protected audio CDs/DVDs.

²⁾ - Mobile phone preparation: The use of a mobile phone inside a car may cause an increase in the interior electromagnetic field strength and, accordingly, in the electromagnetic radiation to which passengers are exposed. The use of the telephone module for PCM via Bluetooth® SAP connection or with inserted SIM card prevents exposure to electromagnetic radiation as only the car's external aerial is ever used.
- For information on compatible mobile phones, please contact your Porsche Centre or visit www.porsche.com.
- Telephone module in HFP mode: The use of a mobile phone inside a car may cause an increase in the interior electromagnetic field strength and, accordingly, in the electromagnetic radiation to which passengers are exposed. The use of the telephone module for PCM via Bluetooth® SAP connection or with inserted SIM card prevents exposure to electromagnetic radiation as only the car's external aerial is ever used.

The vehicles illustrated in the chapter on personalisation may include additional options not featured in this catalogue. For information on these options, please consult your Porsche Centre.
For more information on the options featured in this catalogue, please refer to the separate price list.
– not available ○ extra-cost option ● standard equipment A available at no extra cost



Cordless handset for telephone module

	Cayman	Cayman S		
Audio and communication.				
Option			I no.	Page
• CDR-30 audio system ¹⁾	●	●		90
• Integrated six-disc CD autochanger (for CDR-30) ¹⁾	○	○	692	90
• Universal audio interface (AUX) for audio system (for CDR-30)	○	○	870	95
• Mobile phone preparation (for CDR-30 and PCM) ²⁾	○	○	619	95
• Mobile phone preparation with bracket (for CDR-30 and PCM) ²⁾	○	○	618	95
• Sound Package Plus, including CD storage (for CDR-30 and PCM)	○	○	490	95
• BOSE® Surround Sound System, including CD storage (for CDR-30 and PCM)	○	○	680	96
• External aerial (for CDR-30 and PCM)	A	A	461	



Universal audio interface for PCM

**Audio and communication.**

Option			I no.	Page
	Cayman	Cayman S		
• PCM with navigation module ¹⁾	○	○	P23	92
• Integrated six-disc CD/DVD autochanger (for PCM) ¹⁾	○	○	693	92
• Universal audio interface (AUX, USB, iPod®) (for PCM) ³⁾	○	○	870	95, 126
• TV tuner (for PCM)	○	○	676	94
• Telephone module (for PCM) ²⁾	○	○	666	94
• Cordless handset for telephone module (for PCM)	○	○	669	
• Electronic logbook (for PCM)	○	○	641	94
• Voice control system (for PCM)	○	○	671	94

¹⁾ May be incompatible with some copy-protected audio CDs/DVDs.

²⁾ Please see the notes on page 124.

³⁾ For information on compatibility with iPod® and iPhone® models, please contact your Porsche Centre.

The vehicles illustrated in the chapter on personalisation may include additional options not featured in this catalogue. For information on these options, please consult your Porsche Centre.

For more information on the options featured in this catalogue, please refer to the separate price list.
 – not available ○ extra-cost option ● standard equipment A available at no extra cost

Porsche Exclusive

State-of-the-art. And to your specification.

With the range of options featured in this catalogue, you can make your Porsche even more special. Introducing Porsche Exclusive. Have your vehicle individually and exclusively tailored to your wishes even before it leaves the factory.

Aesthetically and technically, inside and outside, using fine materials and with customary Porsche quality. Our overriding principle? Uniquely handcrafted to your taste. You will find a wide range of design options in the separate Porsche Exclusive Cayman catalogue.

Either your Porsche Centre or the customer centre in Zuffenhausen (tel. +49 (0)711 911-25332) will be happy to answer any questions you may have.

Please note that delivery times may be extended for certain Porsche Exclusive equipment.

Factory collection

You won't be able to sleep the night before.

The night after, you won't want to.

Many of our customers dream of collecting their new Porsche in person. They want to be there when the car of their dreams leaves the factory. This way, they can be the first to take their Porsche to its rightful place: on the road.

Today, all Porsche engines are constructed here in our main factory in Zuffenhausen, where the legendary 356 was built. You can collect your Boxster,

Cayman or 911 from here. If you've chosen a Cayenne or Panamera, this will be waiting for you at their place of manufacture – in Leipzig.

Where better to experience the passion of Porsche than in the place where it all began? A place characterised by a unique blend of past and future. To take advantage of this fascinating opportunity, please inform your Porsche Centre that you would like to collect your vehicle in Zuffenhausen. We will then make all the necessary arrangements to have your Porsche ready by the agreed collection date.

Finding the factory is straightforward. The easiest way to travel

from outside Germany is to fly to Stuttgart, Frankfurt am Main, or Leipzig, and then continue by train, taxi or hire car (which we can return on your behalf).

Please note that there are a number of formalities that must be completed when you take delivery of your new Porsche. For full details, please consult your Porsche Centre, who will also be happy to assist when it comes to planning your trip.

Everything about a Porsche is more intense. Especially the anticipation.

There's no need to rush just yet. Take your time and make the

factory tour one of the highlights of your visit. See Porsche production processes in action for yourself, from engine assembly and the preparation of upholstery to final installation. Experience one of the key moments in the construction of any car: the 'marriage' of engine/chassis and body. The factory tour is one of our oldest traditions and is always conducted by a Porsche enthusiast with extensive knowledge of the marque.

If Zuffenhausen is the destination for your factory collection, then why not also visit the Porsche Museum? Here, you'll find an impressive range of exhibits, including legendary Porsche models that have made key

contributions to the Porsche success story. Awaiting you in Leipzig are an impressive car exhibition and an exciting film presentation about the fascinating world of Porsche. How does a Porsche experience of the culinary kind sound? As part of your factory collection visit, we will be delighted to offer you a three-course meal from our gourmet menu.

If there's still time, you can enjoy some additional refreshments in the customer lounge or simply browse in the Porsche Design Driver's Selection Shop.

The moment you've been waiting for.

The highlight of your visit will undoubtedly be the delivery of your Porsche – handed over by specialists who know it inside and out. They will take their time to explain everything you need to know about your new car and all its technical features.

Then you'll finally experience what it means to own a Porsche.



Vehicle handover in Zuffenhausen



Porsche Museum



Porsche Centres

Your Porsche Centre can assist you with every aspect of purchasing and owning your Porsche. You will also find a wide range of products and services, including genuine Porsche parts and accessories.

Porsche Assistance

Enjoy peace of mind with our exclusive breakdown and accident recovery service. Membership is free when you buy a new Porsche.

Porsche Financial Services

Our innovative suite of financial services is specially tailored to the needs of Porsche owners. Products range from attractive finance and leasing options to vehicle insurance and the Porsche Card.

Porsche Exclusive

Realise your vision of the perfect Porsche with our factory customisation programme. From styling enhancements to performance upgrades, all modifications are uniquely handcrafted for your Porsche.

Porsche Tequipment

Personalise your Porsche at any time after purchase with the Tequipment range of approved accessories. Designed exclusively for your car, every product is fully guaranteed.

Porsche Design Driver's Selection

With products ranging from fashion and accessories to tailored luggage, this unique collection combines quality and style with everyday practicality.

Service

Porsche Used Car Programme

Porsche Approved is the simple way to find the perfect pre-owned Porsche, anywhere in the world. Every car is rigorously tested and comes with a comprehensive vehicle warranty.

Porsche Classic

Your specialist source for genuine Porsche parts and technical documentation as well as servicing, repair and restoration for all types of classic Porsche. Find out more at www.porsche.com/classic.

Christophorus

Our bi-monthly magazine for Porsche owners has news, interviews and a wide variety of features from throughout the world of Porsche.

Porsche Clubs

Since the first Porsche Club was founded in 1952, their number has grown to 613 with a total of 120,000 members worldwide. To find out more, call +49 (0)711 911-78307 or go to www.porsche.com.

Porsche Driving Experience

1. Porsche Travel Club. Exclusive driving holidays and incentive ideas combining luxury and adventure, worldwide. To find out more, call +49 (0)711 911-78155. E-mail: travel.club@porsche.de

2. Porsche Sport Driving School.

Develop your skill and explore your Porsche with the Porsche Sport Driving School. To learn about events at some of the world's most famous racing venues, call +49 (0)711 911-78683. E-mail: sportdrivingschool@porsche.de



Porsche Online

For all the latest news and information from Porsche, go to www.porsche.com.



Ask your Porsche Centre for the latest brochures from Porsche Exclusive, Porsche Tequipment, Porsche Design Driver's Selection and the Porsche Driving Experience.



Summary

The Cayman models. They're sophisticated, mature – but far from conformist. At the core: a resolute drive for power. At the fore: a character that's simply

unyielding. You can see it, you can feel it. With every rev. With every inch of road. The Cayman: an uncompromising declaration of individuality.

Technical data

	Cayman	Cayman S
Engine		
Type	Horizontally opposed cylinder	Horizontally opposed cylinder
Installation	Mid-mounted	Mid-mounted
Cylinders	6	6
Displacement	2,893 cm ³	3,436 cm ³
Max. power (DIN) at rpm	195 kW (265 hp) 7,200 rpm	235 kW (320 hp) 7,200 rpm
Max. torque at rpm	300 Nm 4,400–6,000 rpm	370 Nm 4,750 rpm
Compression ratio	11.5:1	12.5:1
Transmission		
Layout	Rear-wheel drive	Rear-wheel drive
Manual gearbox	6-speed	6-speed
PDK (optional)	7-speed	7-speed
Chassis		
Front axle	Lightweight spring strut suspension	Lightweight spring strut suspension
Rear axle	Lightweight spring strut suspension	Lightweight spring strut suspension
Steering	Power-assisted (hydraulic), with variable steering ratio	Power-assisted (hydraulic), with variable steering ratio
Turning circle	11.1 m	11.1 m
Brakes	Four-piston aluminium monobloc fixed calipers front and rear, internally vented and cross-drilled discs	Four-piston aluminium monobloc fixed calipers front and rear, internally vented and cross-drilled discs
Vehicle stability system	PSM (with ABS 8.0)	PSM (with ABS 8.0)
Wheels	Front: 7 J x 17 Rear: 8.5 J x 17	Front: 8 J x 18 Rear: 9 J x 18
Tyres	Front: 205/55 ZR 17 Rear: 235/50 ZR 17	Front: 235/40 ZR 18 Rear: 265/40 ZR 18

	Cayman	Cayman S
Weights		
	Manual/PDK	Manual/PDK
Unladen weight (DIN)	1,330 kg/1,360 kg	1,350 kg/1,375 kg
Unladen weight (EC) ¹⁾	1,405 kg/1,435 kg	1,425 kg/1,450 kg
Permissible gross weight	1,635 kg/1,670 kg	1,645 kg/1,675 kg
Performance		
	Manual/PDK (SPORT PLUS) ²⁾	Manual/PDK (SPORT PLUS) ²⁾
Top speed km/h (mph)	265 (165)/263 (163)	277 (172)/275 (171)
0–100 km/h (0–62 mph)	5.8 secs/5.7 secs (5.5 secs) ²⁾	5.2 secs/5.1 secs (4.9 secs) ²⁾
0–160 km/h (0–99 mph)	13.4 secs/13.2 secs (12.9 secs) ²⁾	11.4 secs/11.2 secs (10.9 secs) ²⁾
Flexibility 80–120 km/h (50–75 mph) in 5th gear	7.6 secs/–	6.5 secs/–
In-gear acceleration 80–120 km/h (50–75 mph)	–/3.7 secs	–/3.1 secs
Fuel consumption/emissions³⁾		
	Manual/PDK	Manual/PDK
Urban in l/100 km	13.8/13.6	14.4/14.1
Extra urban in l/100 km	6.9/6.5	7.2/6.6
Combined in l/100 km	9.4/9.1	9.8/9.4
CO ₂ emissions in g/km	221/214	230/221
Dimensions/aerodynamics		
Length	4,347 mm	4,347 mm
Width (including exterior mirrors)	1,801 mm (1,952 mm)	1,801 mm (1,952 mm)
Height	1,304 mm	1,306 mm
Wheelbase	2,415 mm	2,415 mm
Luggage compartment volume (VDA) front/rear	150 litres/260 litres	150 litres/260 litres
Tank capacity (refill volume)	64 litres	64 litres
Drag coefficient	0.29/0.29	0.29/0.30

¹⁾Weight is calculated in accordance with the relevant EC Directives and is valid for vehicles with standard specification only. Optional equipment increases this figure. The figure given includes 68 kg for the driver and 7 kg for luggage.

²⁾In conjunction with the optional Sport Chrono Package or Sport Chrono Package Plus and with the SPORT PLUS button selected.

³⁾Data determined in the NEDC (New European Driving Cycle) in accordance with the Euro 5 (715/2007/EC and 692/2008/EC) measurement method. The figures do not refer to an individual vehicle nor do they constitute part of the offer. They are intended solely as a means of comparing different types of vehicle. You can obtain further information about individual vehicles from your Porsche Centre. Fuel consumption calculated for vehicles with standard specification only. Optional equipment may affect fuel consumption and performance.

Index

Term	Page								
A									
Active safety	66								
Airbags	74								
Air-conditioning system	83								
Anti-theft protection	75								
Audio interface, universal	95								
B									
BOSE® Surround Sound System	96								
Braking system	69								
C									
CD autochanger	95								
CDR-30 audio system	90								
Chassis	56								
Child seats	75								
Colours	108								
Cornering lights, dynamic	67								
Cruise control	83								
D									
Direct fuel injection	34								
Dry-sump lubrication, integrated	38								
E									
Engine cooling	40								
Engine management	40								
Engine, flat-six	32								
Environment	98								
Exclusive	127								
Exhaust emission control	100								
Exhaust system	44								
F									
Factory collection	128								
Fuel	103								
Fuel system	103								
G									
Garage door opener (HomeLink®)	84								
H									
Headlight cleaning system	67								
Headlights, Bi-Xenon	67								
Heated seats	83								
Heated steering wheel	81								
Hill-start assist	53								
HomeLink® (programmable garage door opener)	84								
I									
Ignition	44								
Instruments	80								
L									
LED daytime running lights	67								
Logbook, electronic	94								
Luggage compartment, front	86								
Luggage space, rear	86								
M									
Maintenance	103								
Maintenance requirements	45								
Manual gearbox	53								
Materials	103								
N									
Navigation module	92								
Noise	103								
O									
Oil supply	38								
On-board computer integrated	80								
P									
ParkAssist	85								
Passive safety	73								
Personalisation options	106								
Porsche Active Suspension Management (PASM)	60								
Porsche Ceramic Composite Brake (PCCB)	70								
Porsche Communication Management (PCM)	92								
Porsche Doppelkupplung (PDK)	48								
Porsche Side Impact Protection (POSIP)	74								
Porsche Stability Management (PSM)	72								
R									
Rear differential lock	60								
Rear wiper	85								
Recycling	103								
Resonance intake manifold	43								
Roof transport system	89								
S									
Safety, active	66								
Safety, passive	73								
Seat ventilation	83								
Seats, comfort	82								
Service	130								
Side windows, water-repellent	84								
Sound Package Plus	95								
Sport Chrono Package	62								
Sport Chrono Package Plus	63								
Sports bucket seats	83								
Sports exhaust system	44								
Sports seats	82								
Sports seats, adaptive	82								
Standard seats	82								
Steering	58								
Steering wheels	81								
Storage compartments	88								
T									
Technical data	134								
Telephone	94								
Telephone preparation	95								
Transport concept	86								
TV tuner	94								
Tyre Pressure Monitoring (TPM)	59								
V									
VarioCam Plus	43								
Vehicle tracking system	75								
Voice control system	94								
W									
'Welcome Home' lighting	84								
Wheels	59								
Windscreen wipers	84								

